



M&S Projects from Simulation Team



Liophant Simulation



M&S Net



McLeod Institute of Technology and Interoperable M&S
Genoa Center

Agostino G. Bruzzone

agostino@itim.unige.it

www.simulationteam.com

www.liophant.org

www.itim.unige.it

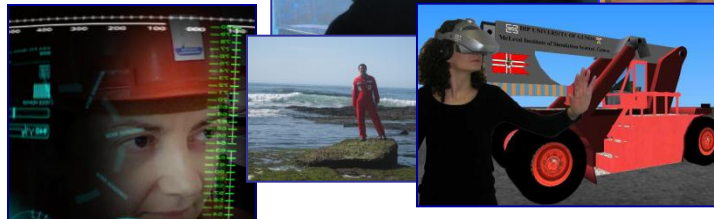
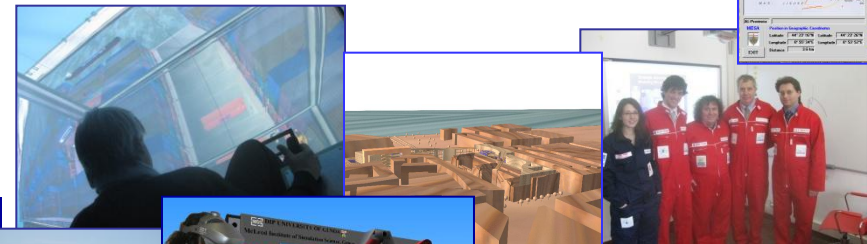

DIPTeM
University of Genoa





Who Are We?

Universities, Research Centers and Companies operating worldwide in synergy for developing Innovative Solutions with a particular focus in Modelling and Simulation



DIME
Università
di Genova



Liophant
Simulation



CentraLabs
Cagliari



CSU
Australia



CIREM
Università di Cagliari



AntOptima
we speed up your business



VIRTUALLY



MSC-LES



Mik
Riga TU



Universidad
de la Rioja



SimCenter Universitat
Autònoma de Barcelona



LOGIXTICA



DIPMEC
Università Calabria



Rio de Janeiro
Brazil



Università di Perugia



LSIS
Marseille



IMS-LAPS
Univ. Bordeaux

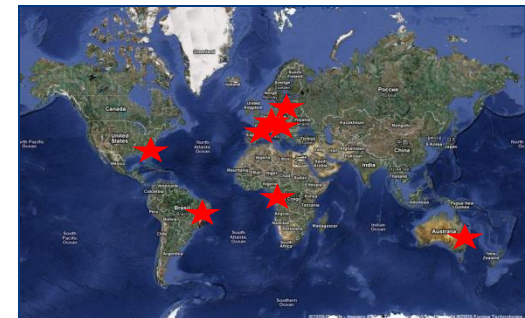

McLeod Institute of
Technology & Interoperable
Modeling Simulation Genoa



SPIIRAS Russian
Academy of Science



DIME
Università di Genova



McLeod Institute of Technology and M&S M&S Net Genoa Center

Email: agostino@itim.unige.it

URL: www.mcleodinstitute.org
www.m-s-net.org



M&SNet

The research group of DIME of *Genoa University* is active from '60 in Simulation applied to Industrial Engineering and is cooperating with M&S Net and MITIM

The activities involve modeling, simulation, VV&A and analysis of Industrial Applications and Services (design, re-engineering, management, training etc.)

as:

Chemical Facilities	Power Plants	PM
Harbor Terminals	Public Services Environment	
Manufacturing	Assembling	Logistics
Public Transportation		

The Department staff is in touch world-wide with the simulation community and is present actively to conferences, exhibitions and working meetings with the major Associations, Agencies and Companies.

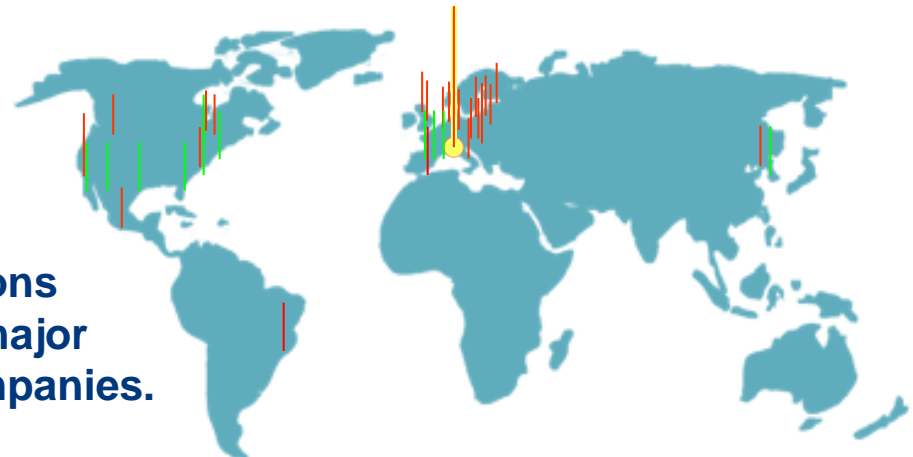

34 M&S Net Centers World-Wide



Simulation Team MITIM DIME

The Simulation Team - MITIM DIME of *Genoa University* carries out many industrial projects in cooperation with the large corporations and Small and Medium sized Enterprises; some example of recent industrial simulation project are following:1

- ENI** Fleet Management Planning & Scheduling
- Group Chemical Plant Logistics Optimization**
- Ansaldo** Plant Service Management and Optimization
- LAMCE** Oil Platform Simulation and Augmented Reality
- Petrobras**
- EDA** Decision Support for Country Reconstruction Activity Planning
- Ford Motor** New Production Line Design Based on Simulation



SOLVAY



Members of MISS are appointed in several positions in simulation community such as:

- General Director M&S Net (34 M&S Centers Worldwide)
- President Simulation Team (20 Centers Worldwide)
- Chairman of Technical Chapter in SCS and Past Associate VP
- Member of NATO SAS, MSG, and NIAG, Project Leader for Marine M&S





DIME - University of Genoa

DIPTTEM was founded in 1997 as evolution of the Institute of Technology and Industrial Management (ITIM) that was operative from '60. In 2011 DIPTTEM evolved in DIME and it is currently composed by about 80 faculty members, 15 technicians and administrative, plus several PhD Students, external Researchers and Consultants. DIME teachers are involved in Undergraduate, Postgraduate and Professional activities in Engineering, Management.

DIME active in R&D Projects for major Institutions, Companies and Governmental Organisations. DIME co-operates actively with major Excellence Centers World-Wide.





University of Genoa: an Overview

The University of Genoa is one of the oldest in Italy and in the World (founded in 1471 AD), it is located in middle of Italian Riviera.

The students are about 40,000 (about 8,000 new entries), and the engineering departments has about 7,500 students (12% in Savona Branch Departments); in effect the Savona Campus Savona holds about 1,000 Engineering Students.

That campus is located about 2 km from Savona Downtown, in an old complex of barracks recently converted into new University Buildings (over an area of 200,000 m²).

For further Information about
the University of Genoa:

<http://st.itim.unige.it>
<http://www.unige.it>

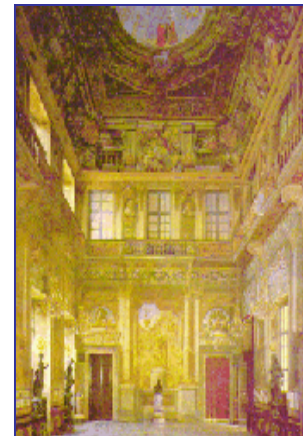



Savona Campus & Facilities

The University of Genoa includes a new campus in Savona about 2 km outside Downtown; bus services and large parking areas guarantee easy access.

That structure has been obtained transforming Army barracks; today the campus includes a big park with facilities such as tennis courts and sport grounds.

The campus holds Depts on Engineering, Economy and Education; new laboratories have been realised by Simulation Team (Cybersar Mobile Lab, HLA Lab).

Facilities for Professional Congress Centres are available in the surroundings



Savona Campus



Simulation Team Labs



Congress Centre





Partners & Spin-Off



Former Students and Researchers from MISS DIPTM Simulation Team created over the years start up companies that currently cooperate in M&S (i.e. MAST srl, Cal-Tek srl, Virtuality, DLM, AntOptima, Etea, etc); these companies are devoted to drive Innovation to Success in a wide spectrum of Application for different Business Sectors, Companies, Corporations, Agencies, Societies and Governmental Services and to put *Modeling and Simulation* to work by creating Outstanding Solutions Essential to a Better, Safer, Healthier and Wealthier Life operating worldwide.



These Partners offer a wide range of innovative products and services for M&S markets including:

- Aerospace
- Defense
- Electronics
- Engineering
- Safety and Security
- Retail
- Environment
- Logistics
- Service to the Society (nutrition, health care)
- Petrochemical
- Energy and Power
- Shipping & Transportation





Liophant Simulation

Email info@liophant.org

Simulation Team



The *Liophant Simulation* involves World-Wide over 120 Scientists and Technicians working in Companies and Academia. The *Liophant* develops Advanced R&D Projects for Real Applications:

The *Liophant Simulation* promotes international Cooperations and exchanges with Excellence Centers World-Wide (i.e. NCS, KSC, VMASC, KPI)

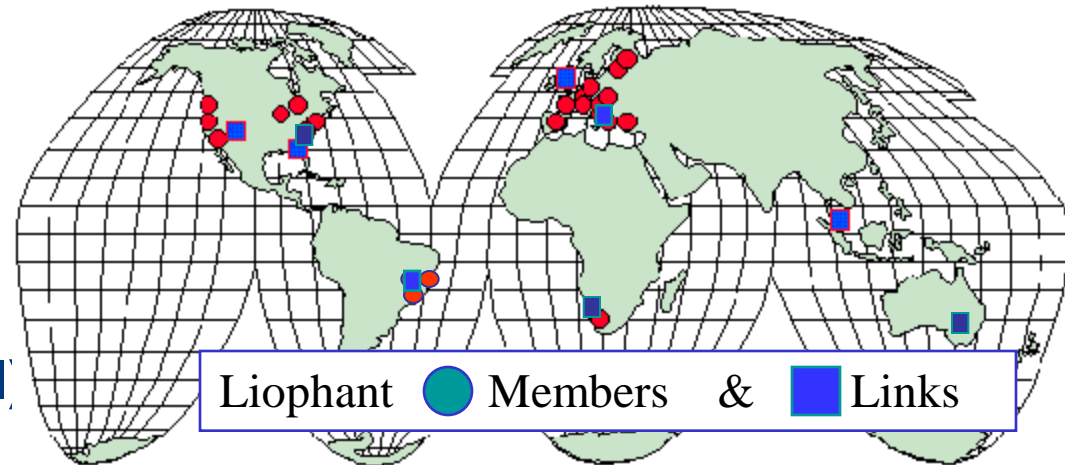

www.liophant.org



The International Activity of Liophant Simulation 2013





The International Activity of Liophant Simulation 2014



Crisis Response Disaster COE, Sofia, M.Biagini

Risk Analysis and Simulation Abu Dhabi, February P.Bortolotto

Exchange Activity PhD, Master, BS

Simulation Team Lab P.Motroni, A.Vueling

Counter Terror Expo London July G.Franzinetti

MCWS&MSTPA NATO STO CMRE September I.Piccini, E.Picco, D.Pereira

Sim&Sea June, M.Corso, L.Dato, M.Agresta, C.Bartolucci

IMS Bordeaux University December Pereira Corso Agresta Bartolucci Nicoletti Picco

NMSG VV&A, Rome October; M.Corso, G.Murino

NATO Simulation Course November, E.Picco

Summersim, Monterey July; C.Bartolucci

ITEC Cologne, May M.Biagini

ITSEC Orlando, November L.Nicoletti, F.Spadafora

Sprinsim & NASA SEE Tampa, April A.Ferrando, L.Dato, F.Spadafora

ICAMES Istanbul, May M.Agresta, A.Bartolucci, A.Ferrando, S.Vena

Simtech, Brisbane June, M.Biagini

WAMS & CAX Forum Istanbul, Sept Bartolucci

Liophant Simulation



Simulation Technology Transfer



Since 2000 Simulation Team - DIPTeM support Professional and Academic MITIM International M&S Certification Program:

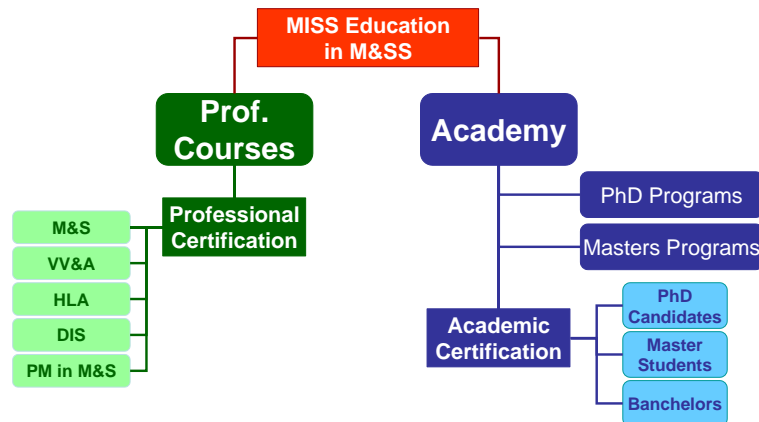

Course Location



Lecturing



Team Working & Exercises

The Lecturers included experts from major excellence centres (i.e. Boston College, Genoa University, NASA, DMSO, National Center for Simulation, SAIC, Aegis, CSY., Riga TU, UCF, McLeod Institute of Technology and Inter.M&S). The Professional course attendance (PM >100, M&S 60, HLA 40, VV&A 20) included Companies (i.e. Piaggio Aero Industries, Alenia Aeronautica, Alenia Marconi, SIA, Fincantieri, COOP), Academia (Pol.Torino, TU Delft, Univ.Marseille, Pol.Milano, Univ.Firenze, Univ.Bari, Univ.L'Aquila, etc.) and National and International Services (i.e. Army, Navy, Air Force, Joint Forces)



SIREN Professional Courses

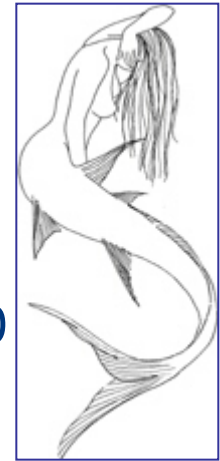

The professional courses have been organized since 2000 for World-Wide professional experts and technicians, in English, Italian and French, including:

- PM: Project Management for M&S
- M&S: Modeling & Simulation
- Interoperability M&S
- HLA: High Level Architecture
- VV&A: Verification, Validation & Accreditation
- RCM: Reliability Centered Maintenance

The courses include lecturing and exercises; teachers are usually world wide experts from major excellence centers (i.e. Boston College, MITIM Genoa University, NASA, DMSO, National Center for Simulation, SAIC, Aegis Technologies, CSU, Riga TU, UCF, M&S Net, etc.).

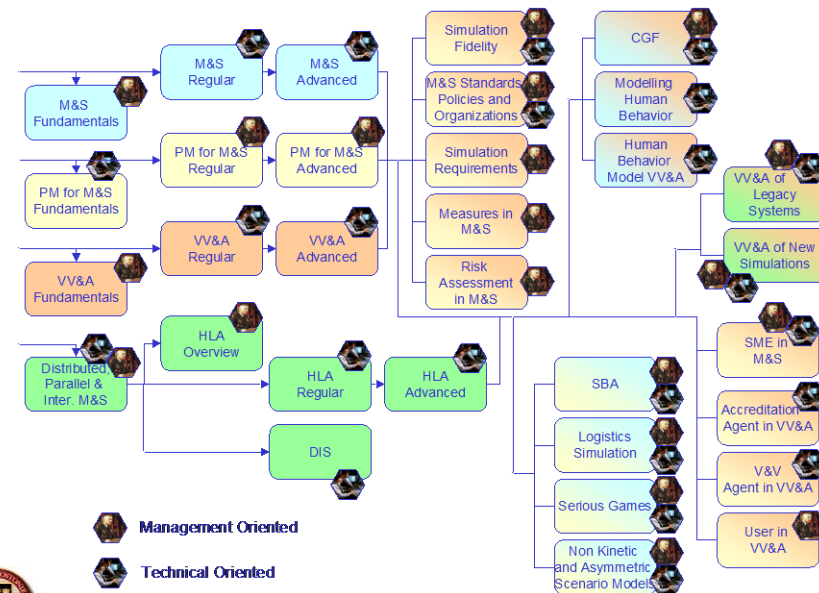



SIMCJOH VIS & VIC

*Simulation of Multi Coalition Joint Operations involving Human Modeling
Virtual Interoperable Simulation & Virtual Interoperable Commander*

Simulation Team

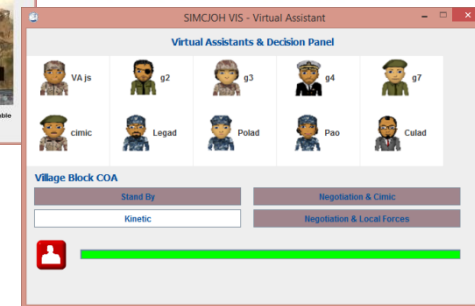

The SIMCJOH (Simulation of Multi Coalition Joint Operations Involving Human Modeling) is a MS2G (Modeling & Interoperable Simulation and Serious Game) project for Strategic Decision Making; SIMCJOH is lead by Genoa University and provides an HLA interoperable immersive framework for the Commander and his staff within critical decision making over Joint and MultiCoalitions scenarios, considering a strong impact of human factors Simulation Team Models on population and Human Behavior Modeling are Extensively.

The experimentation faces issues related to strategic decision making over complex scenarios

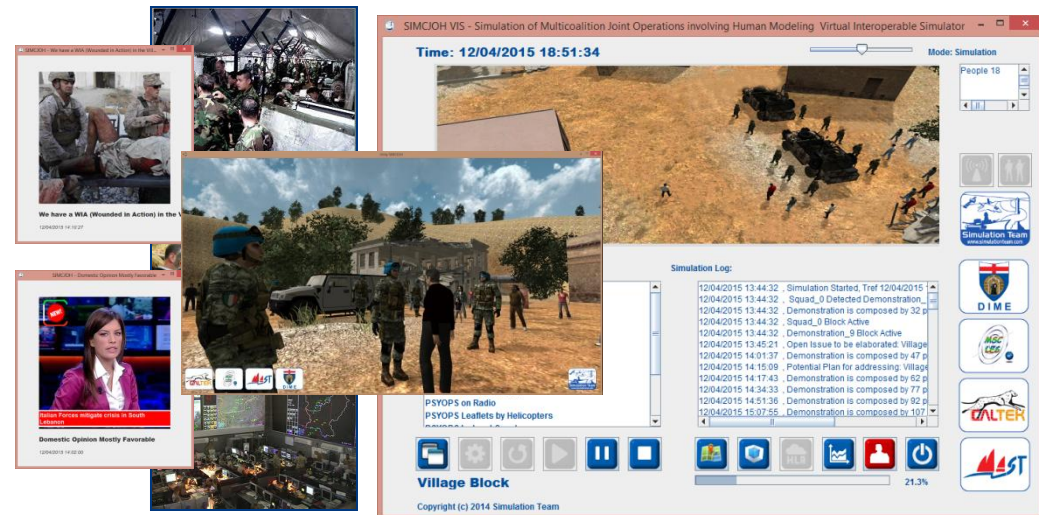



SIBILLA

*Simulation of an Intelligence Board
for Interactive Learning and Lofty Achievements*

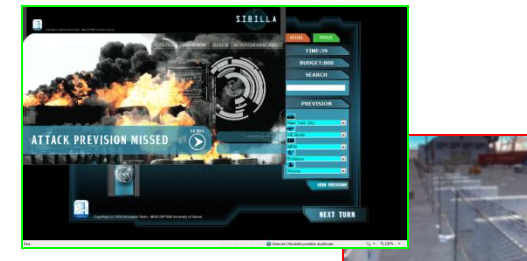

- SIBILLA is multiplayer web strategy game that simulate Terrorist Actions organized by different organization directed by IA that plan, prepare and execute attacks on specific:

- Location
- Site
- Time
- Threat Type



- The intelligence reports are distributed among the players based on their capabilities and shared by a stochastic engine
- The Identification of the attacks in time is the key for individual success; the players cooperate and compete for budget and success
- Threat missed to be identified generate terrorist attacks that reduce global trust and support to intelligence agencies

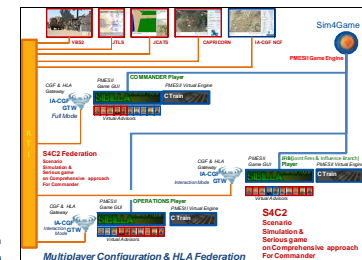



DYTACCO

*DY*namic *T*argeting *C*ollateral *d*amages and *C*onsequences



DYTACCO is a dynamic Targeting Simulator focused on evaluating collateral damages, risks and consequences of operations in complex contexts. DYTACCO is a Serious Game conceived for Commanders and Staff training over new mission environments.

The Simulator proposes challenging Opportunity and Dynamic Targeting Cases to the JFIB (Joint Fire and Intelligence Branch), requiring them to define the Decision Making Briefing for Commander considering risk, collateral damages, consequences, second effects, available assets, caveats, etc. The Commander finalizes the decision on the Dynamic Target Case that is elaborated by the simulator providing direct and indirect outcomes of the different alternatives on the scenario, population and interest group reactions.

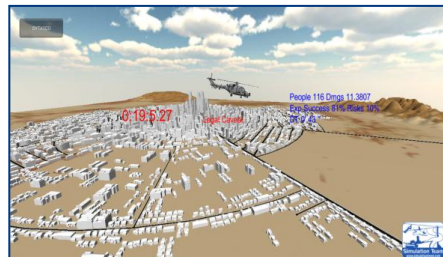



SGT-SDM

Serious Games for Training in Strategic Decision Making



ACT has activated the SGTSDM as a R&D Project to investigate the use of Serious Games for Training in Strategic Decision Making. The project involves an international team including ACT, NATO Defense College, ARRC, M&S COE, Simulation Team, MITIM DIPTM University of Genoa and MAST.





CAPRICORN

Civil Military Co-operation And Planning Research in Complex Operational Realistic Network



- CAPRICORN is a EDA R&D Project devoted to develop capabilities in the complex and critical sector of Military Operation Planning, specifically for asymmetric warfare scenarios involving CIMIC and PSYOPS, by using CGF (Computer Generated Forces) based on Intelligent Agents (IAs)

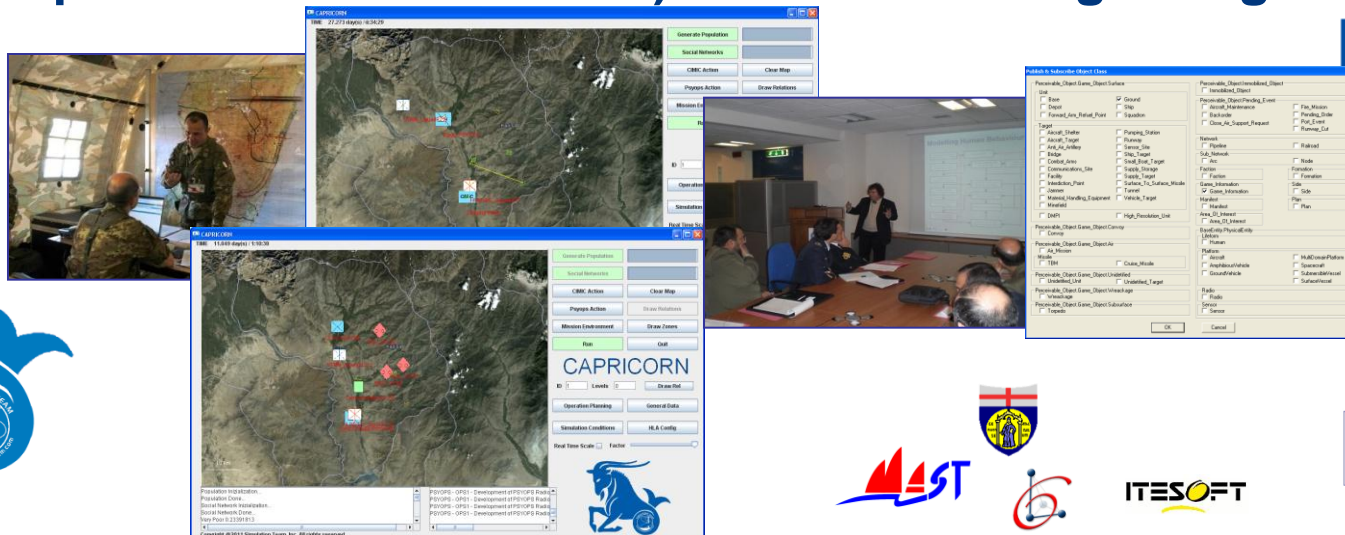



Haiti Case

IA-CGF NCF Riots & IA-CGF NCF EQ

The Demonstration was based Haiti Earthquake 2010 and presented by USJFCOM at ITEC within 2 months.

The demonstration was devoted to show the potential of interoperability in combining different simulators for full coverage of a complex problem such as that one of Haiti.

Simulation Team was involved by using his interoperable IA-CGF reproducing Population Behavior, Human Factors (famine, stress, diseases, fear, aggressiveness), Riots and Gang Activities as well as the impact of the Simulation Earthquake



Simulation Team

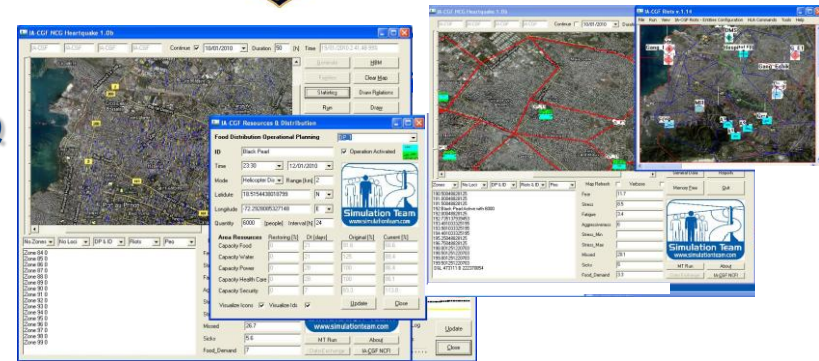



RATS

Riots, Agitators & Terrorists by Simulation



RATS is a demonstrator based on Intelligent Agents for simulating Riots, Civil Disorders as well as Agitators and Terrorists actions within Urban Scenarios considering different entities and influence of Human Factors such as :

*Paramilitary Forces
Police Forces
Military Units
Population*

*Terrorists
Firefighters
NGOs
Protesters*

*Warlords
Health Care
Governmental Entities
Ethnic Groups*



	CHERMAN POPULATION	GRANES MINORITY	SAXONS MINORITY	SECURE FORCE	SEQUESSA LOCAL POLICE	SEQUESSA FEDERAL POLICE	SAXONS LIBERATION FRONT	SEQUESSA LIBERATION MOVEMENT	BLUE FORCES	RED FORCES
CHERMAN POPULATION	Neutral	Neutral	Neutral	Neutral	Neutral	Neutral	Neutral	Neutral	Neutral	Neutral
GRANES MINORITY	Neutral	Neutral	Neutral	Neutral	Neutral	Neutral	Neutral	Neutral	Neutral	Neutral
SAXONS MINORITY	Neutral	Neutral	Neutral	Neutral	Neutral	Neutral	Neutral	Neutral	Neutral	Neutral
SECURE FORCE	Neutral	Neutral	Neutral	Neutral	Neutral	Neutral	Neutral	Neutral	Neutral	Neutral
SEQUESSA LOCAL POLICE	Neutral	Neutral	Neutral	Neutral	Neutral	Neutral	Neutral	Neutral	Neutral	Neutral
SEQUESSA FEDERAL POLICE	Neutral	Neutral	Neutral	Neutral	Neutral	Neutral	Neutral	Neutral	Neutral	Neutral
SAXONS LIBERATION FRONT	Neutral	Neutral	Neutral	Neutral	Neutral	Neutral	Neutral	Neutral	Neutral	Neutral
SEQUESSA LIBERATION MOVEMENT	Neutral	Neutral	Neutral	Neutral	Neutral	Neutral	Neutral	Neutral	Neutral	Neutral
BLUE FORCES	Neutral	Neutral	Neutral	Neutral	Neutral	Neutral	Neutral	Neutral	Neutral	Neutral
RED FORCES	Neutral	Neutral	Neutral	Neutral	Neutral	Neutral	Neutral	Neutral	Neutral	Neutral





SLAMS

Simulation Lean Advanced Mobile Solutions



Microsoft



New technologies make possible to develop simulation solutions tailored for smartphones and tablets; SLAMS (Lean Simulation Advanced Mobile Solutions) is research coordinated by University of Genoa with the aim to identify solutions for education and training for defense, this goal will be reached through models and simulators which are expected to take advantage from these hardware solutions.

In particular, Serious Games based simulators for training will be developed, in terms of approach and engines for games as well.





CRYSTAL

Cyber Reality Simulation for Threat Assessment and Defense Learning



Simulation Team

Microsoft



The CRYSTAL is a research coordinated by Genoa University. CRYSTAL Goals is to develop a simulation framework able to simulate Cyber Defense scenarios related to the Different Layers representing Strategic National Assets (i.e. energy, communication, finance, transportation); CRYSTAL is a modern interoperable architecture allowing a modular approach aimed at advancing the research in a Cyber Defense by using a federation of interoperable stochastic simulators driven by IA-CGF (Intelligent Agents Computer Generated Forces).

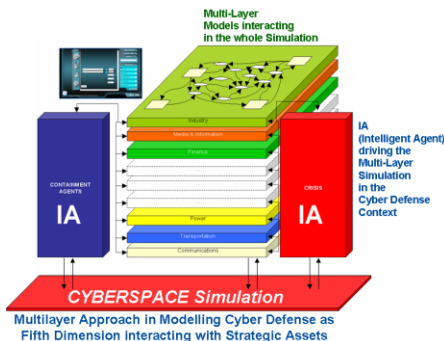



IA-CGF UCOIN

Intelligence Agent Computer Generated Forces UAV and Counter-Insurgency



IA-CGF UCOIN is a Stochastic Simulator of Joint Operations involving UAV (i.e. Rapiers and Predators) for Counter Insurgency in coordination with other assets (i.e. ground units, attack helicopters, planes).

IA-CGF UCOIN allows to simulate complex scenarios where population and civilians are used to hide and shield insurgent activities and to estimate operative performance as well as collateral damages and costs. IA-CGF UCOIN is a support to evaluate technological improvements as well as new operative policies, procedures and to experiment doctrine and enemy tactics evolution.

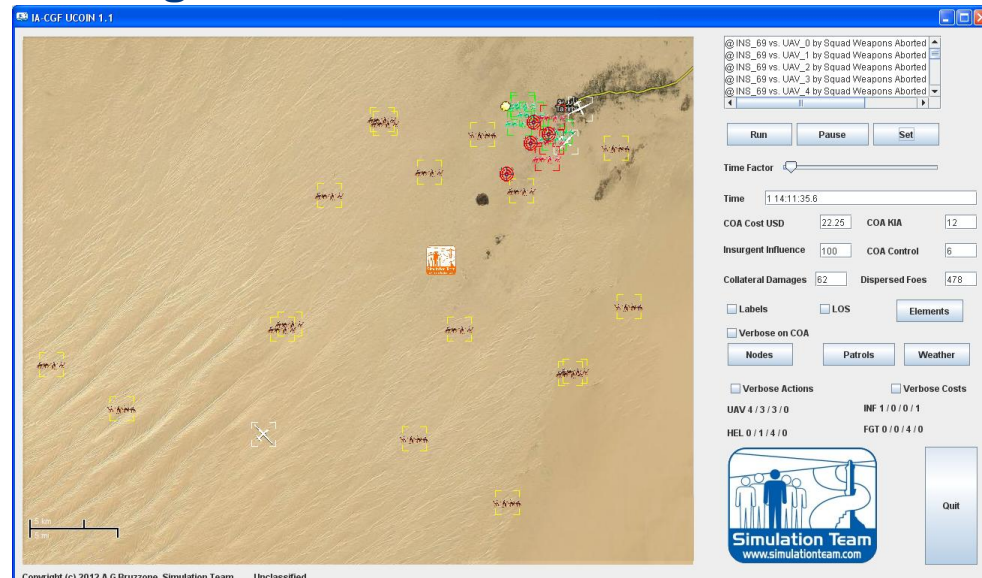



ST_VIV

Simulation Team Virtual Intelligent UAV & AUV



ST_VAV is a Real-Time Agent Driven Simulation of Autonomous Vehicles that operates as swarms and to test Virtual Manned Drone Concept within an HLA Federation (ST_VP Federation). This Synthetic Environment supports different types of UAV (i.e. Predator, Reaper and UACV) and AUV (autonomous underwater vehicle) such as sea gliders. Currently ST_VAV allows to manage different swarms of UAV (i.e. 12 Unmanned Aerial Vehicles) flying as a wing controlled by a Intelligent Agents or directed by an Operator immersed in the Simulation Team CAVE (Covering 270° Horizontal and 120° Vertical, 6 DOF and/or 3 DOF Motion Platform, 3D Stereo Surroundings) integrated with Biometric Devices (i.e. eye flickering, eye tracking, cardio frequency, muscular tone).

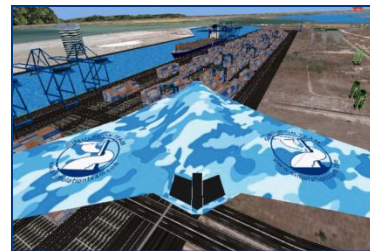



IA-CGF MODULES

The new *IA-CGF* Modules devoted to create the simulation of complex Scenarios include:

- *IA-CGF Units*
- *IA-CGF Human Behaviors*
- *IA-CGF Non-Conventional Frameworks*





IA-CGF Units

IA-CGF Units are a set of interoperable units with capability to be integrated in constructive simulation

- Police
- Gangs
- Local Population
- Rioters
- Insurgents
- Terrorist
- Local Authorities
- Warlord
- Criminal Organizations
- NGOs (CIMIC ops.)
- Civil Personnel (CIMIC ops.)
- Domestic/National Situation (for instance for troops moral):
 - Population
 - Media
 - Lobbies
- International Public Opinion
- International Diplomacy
- New Threats (i.e. 2nd Generation Terrorists)



These are examples of non-conventional units controlled by IA-CGF





IA-CGF Human Behaviors

Specific modules with *IA-CGF Human Behaviors*:

- Fear
- Stress
- Fatigue
- Training Level
- Aggressiveness
- Ethnic Factors
- Religious Factors
- Combat Skills/Experience

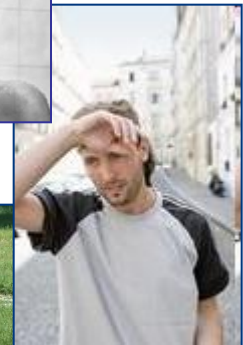

IA-CGF Human Behaviors operate as a set of further characteristics to be added to each unit in constructive simulation.

i.e. now in constructive simulation every unit in the scenario have infos about status and type of ammo, by IA-CGF it will be added dynamic information about level of fear and stress and the Units performing according to it



IA-CGF Non-Conventional Frameworks



It is important to consider the integration in a scenario of the *IA-CGF-Non-Conventional Frameworks (IA-CGF-NCF)*, each simulating specific events:

- *IA-CGF CIMIC/HUMANITARIAN FRAMEWORKS*

- Food Distribution
- Reconstruction



- *IA-CGF Homeland Security and Civil Protection FRAMEWORKS*

- Natural Disaster (i.e. Hurricanes, Earthquakes)
- Man Made Disasters (i.e. Explosion, Hazardous Material Spills)
- Evacuation



- *IA-CGF PSYOPS and INTELLIGENCE FRAMEWORKS*

- Integration *Sibilla*® Serious Game for Intelligence Officers training

In non conventional scenarios for particular training purposes.

We can imagine to have active different non conventional

Frameworks, in different locations, with different level of detail inside the simulated theater.





CeSiVa

CGF C4 IT

Computer Generated Forces C4 for Italian Army



CGF C4 IT Project allows to measure the effectiveness of different C2 Maturity Models involving local and coalition forces, police and other resources in an foreign urban framework. This Federation is based on use of IA-CGF and SC and is devoted to support Italian Army Simulation in term of experimentation and analysis of technologies and policies

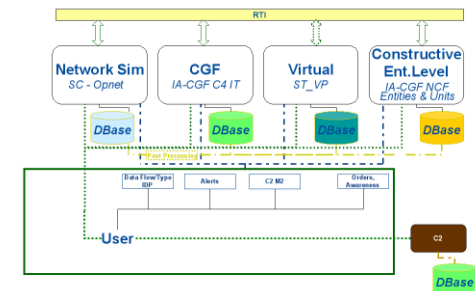
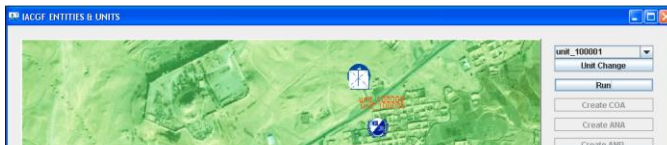



MIAC

Models of Intelligent Agents for Computer Generated Forces



Simulation Team



MIAC NCF and MIAC Configurator are designed to drive a Federation where the IA-CGF allows to reproduce population within an Afghan Village. MIAC Federation is designed to operate under HLA using RTI MÄK on Workstations using Windows XP™ O.S. and installing IA-CGF NCF MIAC© derived by IA-CGF NCF PSYSOP© MIAC is interoperable with other federates (i.e. Scenario Generators) while the MIAC Configurator supports the Scenario Definition

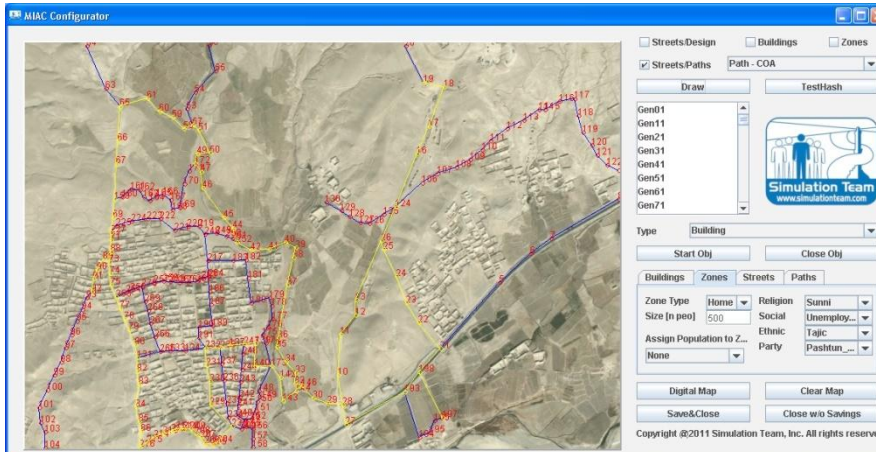
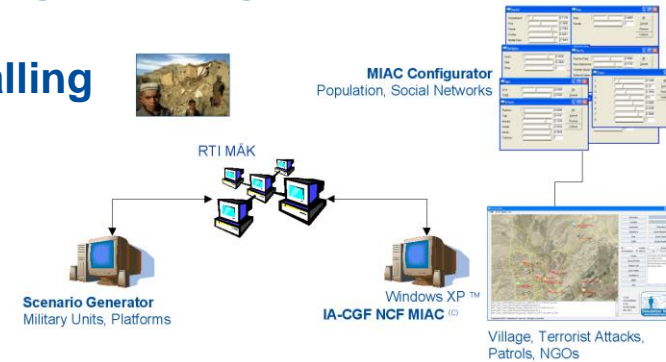



INDASTRIA

This model is inspired by real case and simulate a region subjected to social, economic crisis, it includes:



- Small Region Simulation
- Social Multi Ethnic Reality
- Real & Fake Economy
- Civil Disorders
- Federal vs. Local Authorities
- Polices vs. Crime Organizations

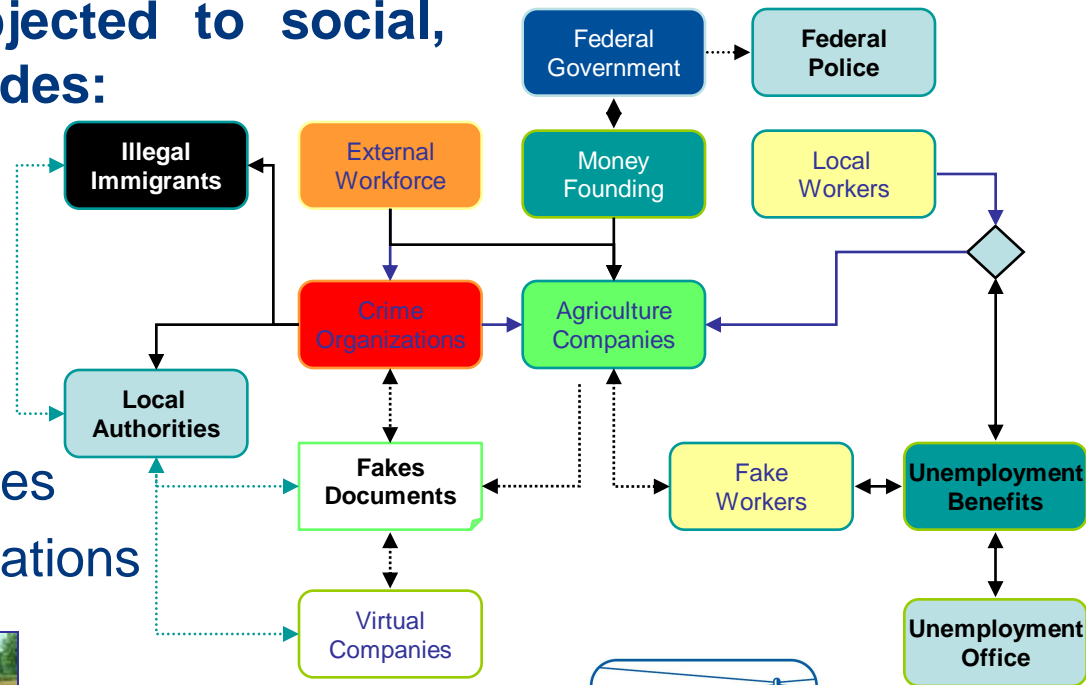



MOSCA

MOdelling Supply Chain Attacks



MOSCA project is devoted to the development of Models for estimating the impact of attacks or disasters affecting supply chain of consumer goods; MOSCA includes dynamic impact of events on consumer emotions as well as effectiveness of countermeasures

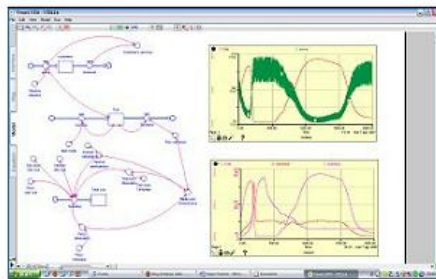
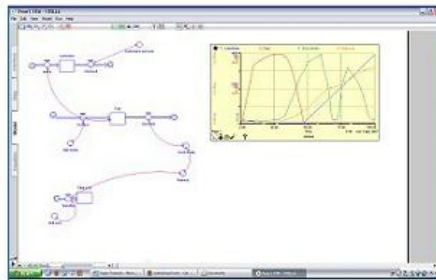

Simulator of Attacks to Retail Chains.txt - Blocco note

File Modifica Formato Visualizza ?

Event: Contaminated Fresh food Bad media: Moderate Aggression

Fear perception: 11

Store Code: 62 Division code: 6

Media Spending: Internet 34, Television 33, Press 25

Delay: Internet 20, Television 10, Press 30
Duration: 60, 00, 30

Media Unit Cost: Internet 1, Television 2, Press 3

Average Arrives rate: 47 Average Checkout rate: 47

"Terrorism Attack In Retail Buisness" Simulator

GO!

Load

Simulatore / Codici / Historical / Matrix / Fear / Arriving / Badmedia / Medium / Spending / Timecardown / Old-Data / data /



ASPID

Advanced Supply chain Protection & Integrated Decision support System



This research is focused on the development of innovative tools for analyzing and optimizing the risk related to the evolution of the elements in the supply chain. ASPID proposes an innovative use of modeling for evaluating the impact on the supply chain of different aspects such as international competition, know-how diffusion in new areas, critical events and disasters

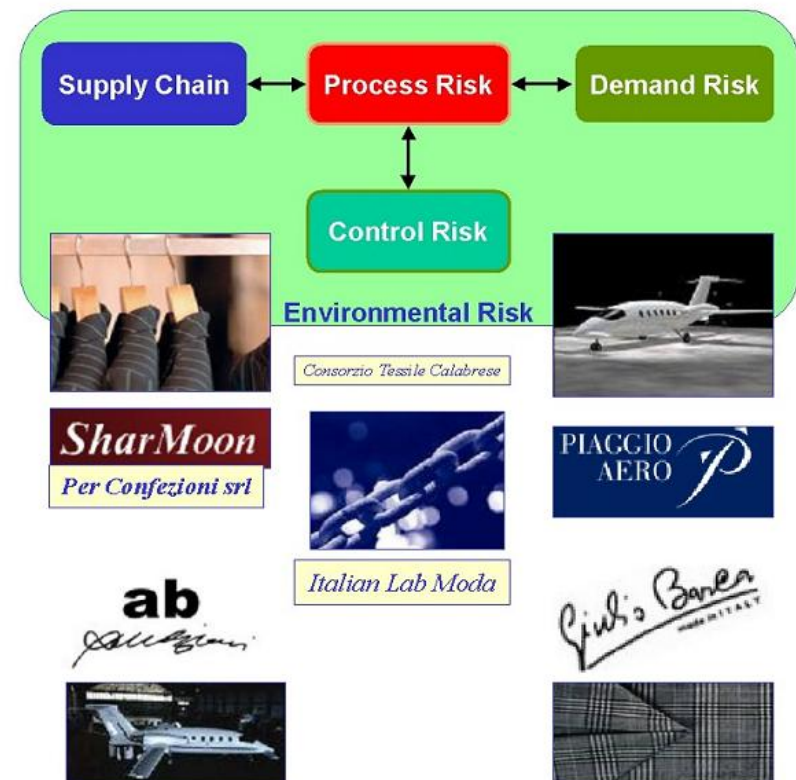



RAILSEC

Railways Security

The project concentrated in developing models for Risk Analysis related to Security in Rail Environments. The project develop emergency management and event simulators as well as model devoted to identify medium and long term effects in term of costs, resources and impact on the overall environment.

The project was developed in cooperation with Institutes in North America and focused on terrorist attack issues

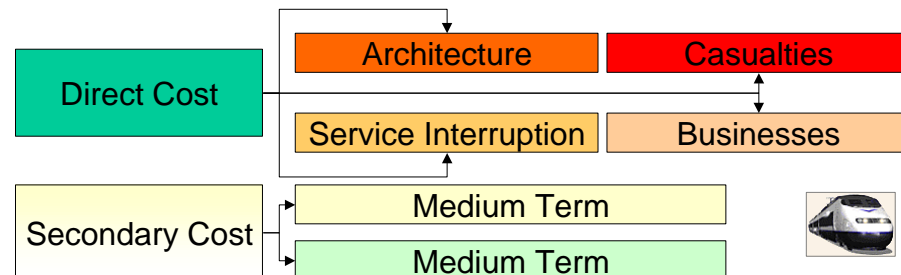
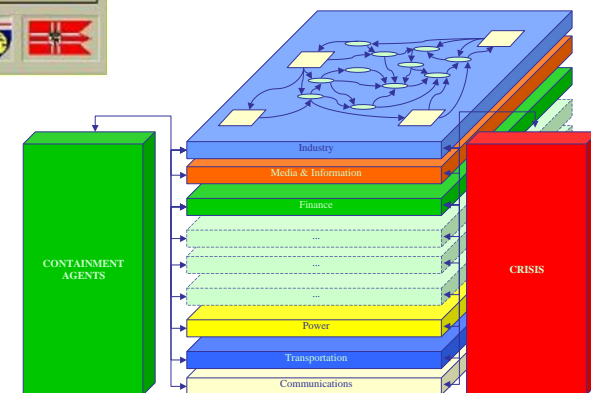

Simulation Team
Genoa Center





SESISEP

Security Simulation of Sea Port

The project concentrated in developing simulation models to support Security in Ports in term of Risk Assessment, Training, Security Solution Analysis, etc. The initiative is modeling ports, terminals, operative procedures, regulations & policies.

The model was successfully applied to evaluate the impact of ISPS, MTSA and SCI evolution in large container terminals. A demonstrator is available on:

www.liophant.org/projects/secsim

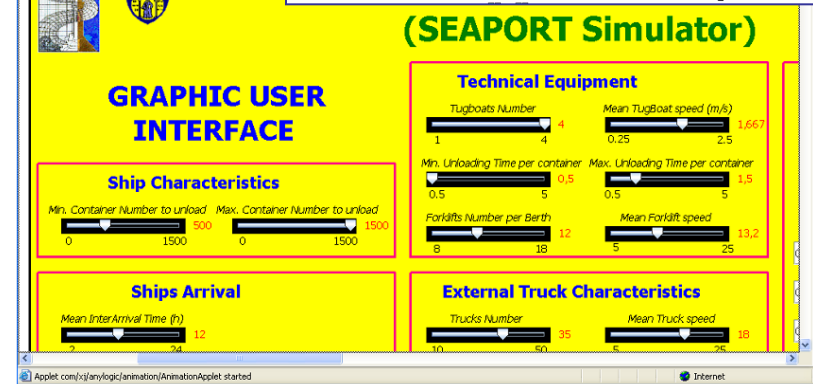
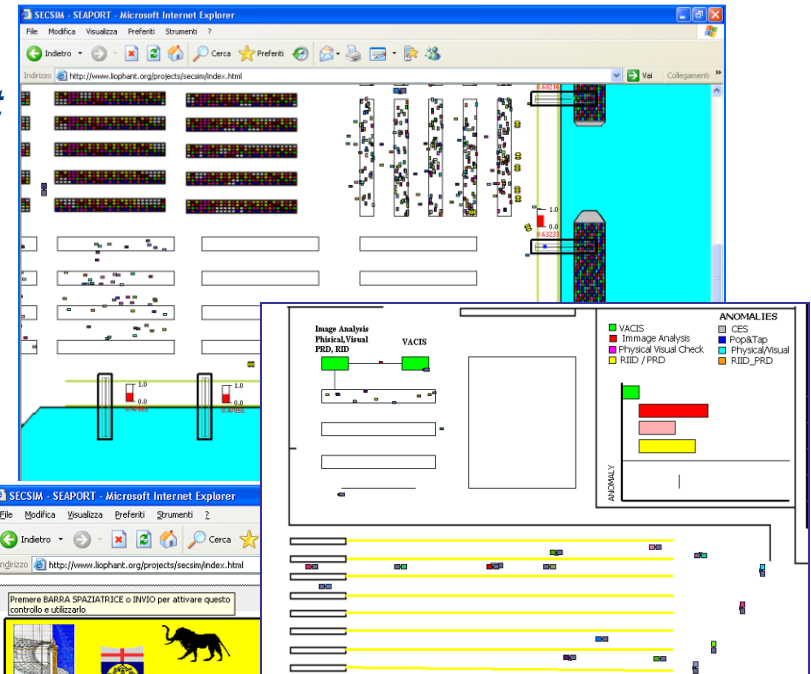



PANDORA

PANdemic Dynamic Objects Reactive Agents



- PANDORA addresses the dynamics of the spreading of a Pandemic and experiments are on-going on H1N1 influenza A virus by a joint simulation project involving USA, European and Australian R&D Centers (MITIM DIPTM, Dartmouth College, CRiCS).
- PANDORA proposes to use an evidence-based approach whereby statistical data (census) and ethnographic surveys are source for the model and integrated with Human Factors representing the psychological and social parameters impact on people behaviors and their reaction to containment measures and policies
- PANDORA evaluates the efficacy and cost benefit of various mitigation strategies such as school closures, target anti-viral prophylaxis and other mitigation measures, level of absenteeism, and its impact on commerce, industry, economy and functioning of society as well as population attack rate, risks related to specific groups and on flows across State borders.

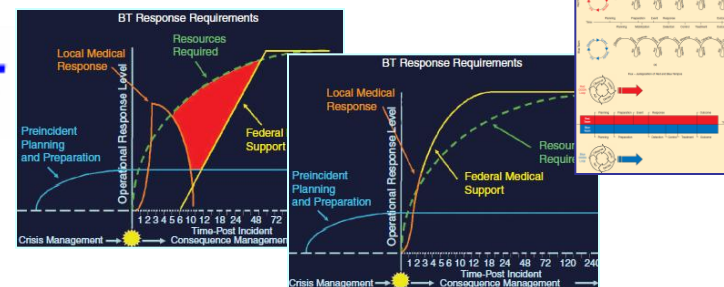
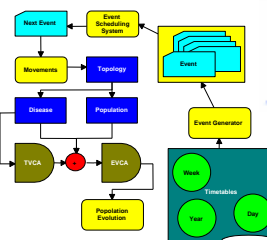
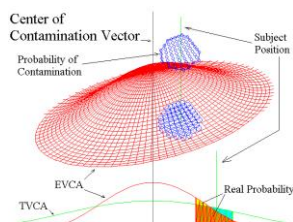



DVx2

Distributed Virtual Experience and Exercise



DVx2 is a MS2G (Modeling, interoperable Simulation and Serious Game) devoted for NATO HQs by STO CMRE for with support of Simulation Team to Demonstrate Vulnerability Reduction in the Defence Against Terrorism (DAT). DVx2 is a Virtual Interactive Exercise enabling NATO DAT PoW, Subject Matter Experts (SMEs) and NATO Executives to demonstrate, validate, benchmark & appreciate the Defense Against Terrorism accomplishments. DVx2 drives Virtual Terrorists & Defenders by using Intelligent Agents and enables to generate Tests and Experience, by Simulation as a Service (SaaS) paradigm, on improvements and challenges such as Vulnerability Reduction, Technological and Organizational Advances, etc. DVx2 by his Web approach provides an innovative capability to immerse Decision Makers, SMEs, Alliance, Nations and General Public in Intuitive and Interactive Experiences over NATO DAT PoW scenarios

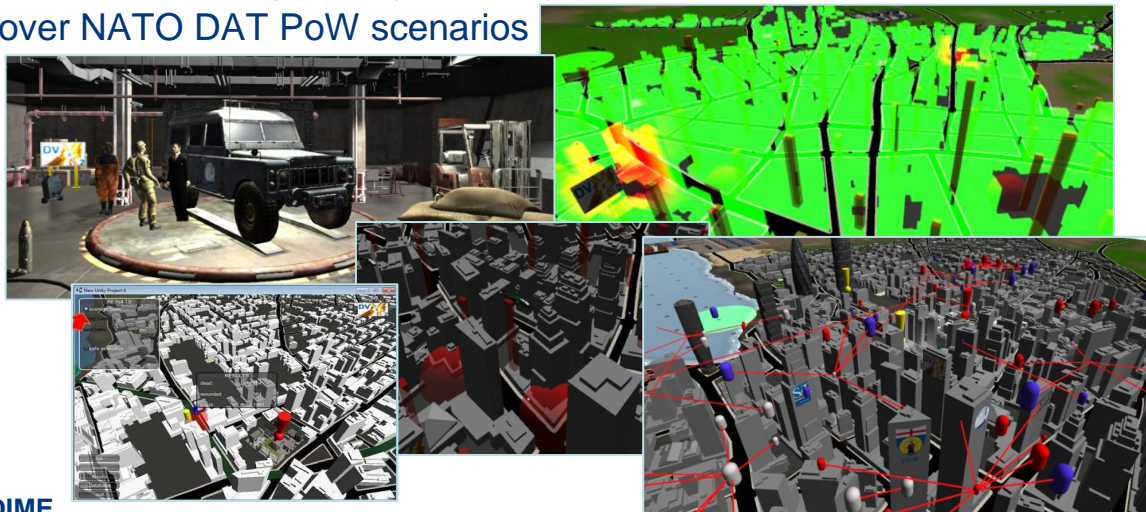

DVx2 focuses on scenarios involving:

- C-IED/EOD Counter Improvised Explosive Device / Explosive Ordnance Disposal
- JISR, Joint Intelligence Surveillance and Reconnaissance
- CBRN, Chemical Biological Radiological & Nuclear





MCWS

Marine Cyber Warfare Simulation



Simulation Team provided support to CMRE for the development of MCWS with special attention to use of IA-CGF and HLA modules. MCSW Simulator was developed to investigate complex scenario combining traditional battlefield operations (Sea Surface, Underwater, Air, Space) with action on the Cyberspace. The simulator evaluates the impact of Cyber Attacks and Defense actions respect the evolution of the situation. The mission environment involves multiple autonomous systems operating over an heterogeneous network involving both classified and unclassified computer infrastructures. MCWS was federated in RTI and tested integrated with CMRE MSTPA (Multi Static Tactical Planning Aid) respect ASW (Anti Submarine Warfare) Mission Environments

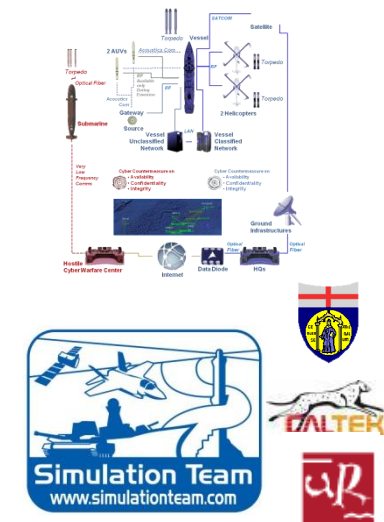
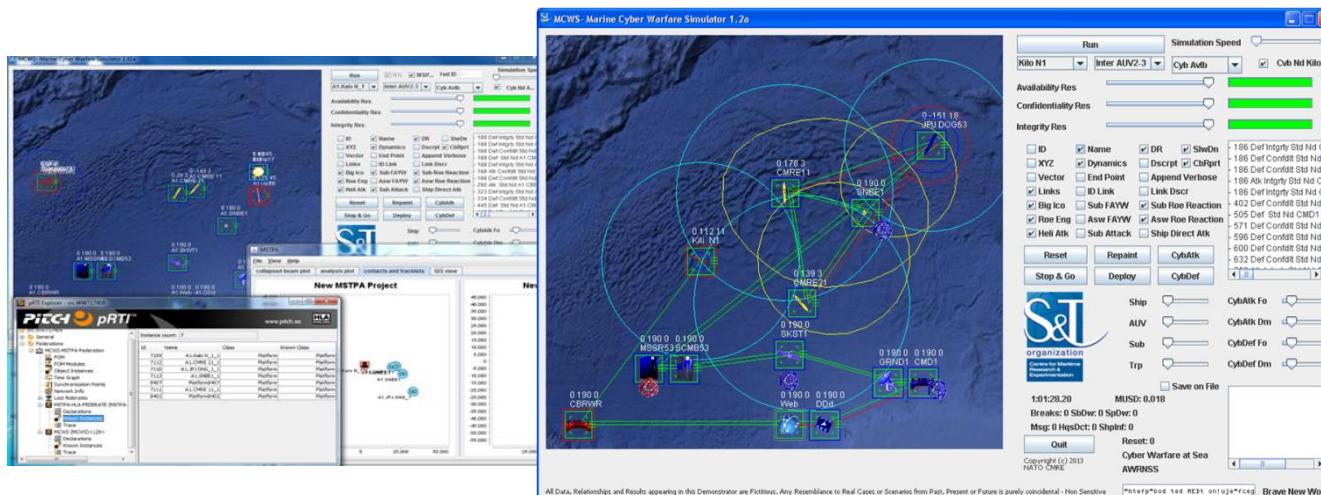



CUMANA

*Cooperative/Competitive Utility for Management
and Advanced Networking skill Acquisition*

CUMANA is a Web Multiplayer Game that provides the opportunity to play interactively a cooperative/competitive game, in a distributed environment where different “Managers” operate concurrently with benefits and penalties connected to both common and individual objective achievements related to their role in their Corporation.

The main goal is to share information in order to support Decisions Making in a Corporation Framework based on market reports affected by risks

The Identification of the market event in time is the key for individual success of each player as well as the overall corporation, while risks not properly addressed generate losses for the whole players





PAS

Plant Advanced Simulation

The PAS (Plant Advanced Simulation) is an initiative for developing a real-time distributed interoperable simulation of complex industrial plants to support different aspects including design, engineering, training. The simulation environment could be used to improve safety and security as well as to support education.

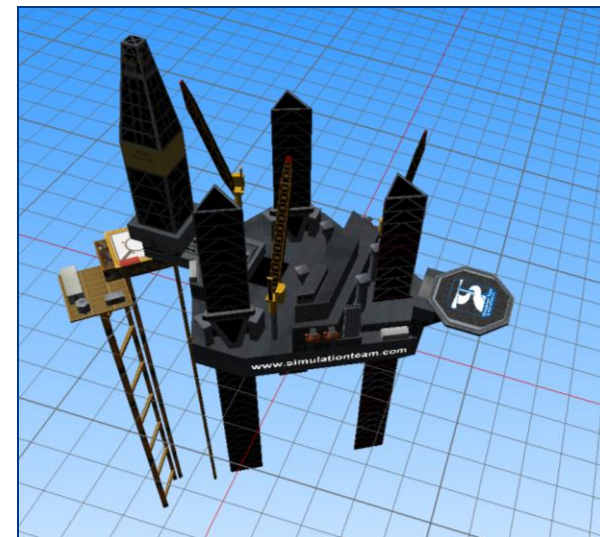
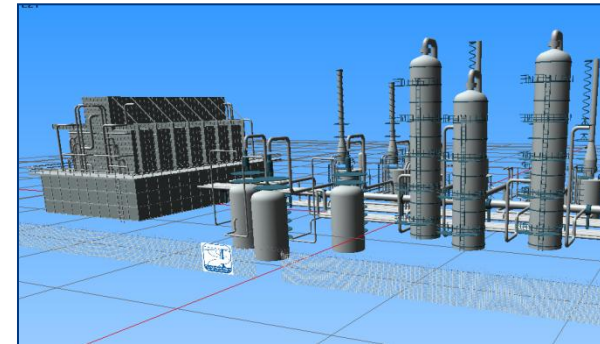
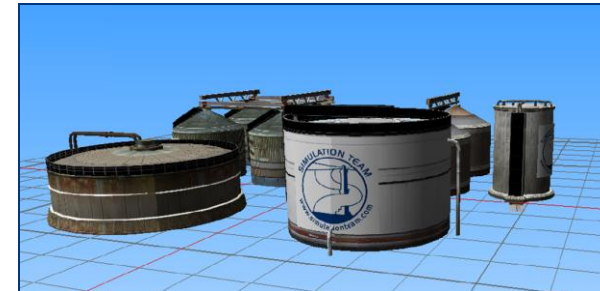
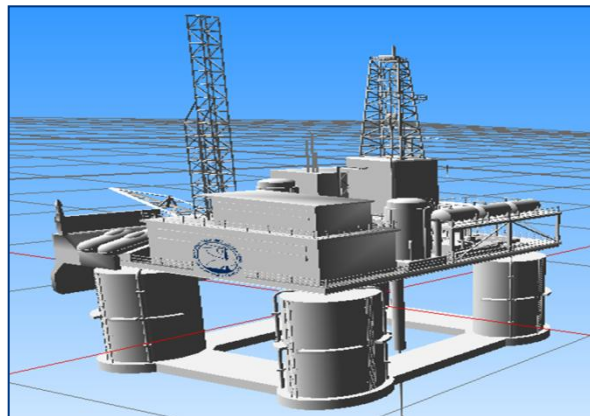
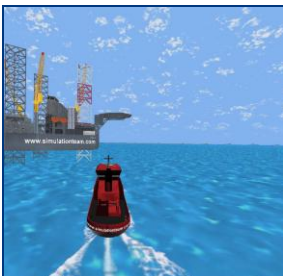



CALYPSO

Carrier Life cYcle Period Simulation & Optimization

CALYPSO project investigated methodologies and techniques devoted to analyze the Life Cycle of the New Italian Carrier Cavour. CALYPSO included development of Tools for comparing costs, operations and performances of different Carriers.

swbs	descrizione
	sistema_piattaforma
	sistema_combattimento
	sistema_integrato_di_telecomunicazi
200	impianto_di_propulsione
300	gruppo_impianto_elettrico
400	gruppo_comando_e_sorveglianza
500	gruppo_impianti_auxiliari
45111	radar_di_scoperta_navale
41211	sottosistema_comando_e_controllo
41511	sottosistema_data_transfer_system
45112	sottosistema_radar_di_navigazione
42811	sottosistema_di_navigazione
48412	sottosistema_meteo_oceanografico
440	sottosistema_di_comunicazioni_ester
430	sottosistema_di_comunicazioni_inter

CALYPSO - Carrier Life cYcle Period Simulation & Optimization
PLANE EVALUATION

Historical data | Plane | Coeff menu

Ref-Comparison: Nimitz-Cavour

Direct operating and support cost

Personnel coeff	N° personnel	0.313
Fuel coeff	hp	0.421
Depot maintenance	Full load displacement	0.335
Others	Acquisition cost	0.670

Indirect cost: Training, Fuel del, Other

Click for final estimation

Main menu | Historical data | Technical data | LCC fiscal (30 years)

2005 © Copyrights DPTM University of Genoa

ACASO: Advanced Carrier Acquisition cost Simulation & Optimization

Historical data | Technical data | LCC fiscal year 97 (90 years)

2005 © Copyrights DPTM University of Genoa

8.20424	8.43488
8.20424	8.43488
8.20424	8.43488
11.724	13.4826
11.724	13.4826

File: AV: 2005-07 | Name: Cavour | Shipyard: 9702-00 | Shipyard: 9702-00

000134

Cost results

evaluation

2005 © Copyrights DPTM University of Genoa





ACASO

Advanced Carrier Acquisition and Operation cost Simulation & Optimization



ACASO is a system for design new Vessel by simulating their performances in relation to their operative profiles and maintenance policies. The system estimates the unknown characteristics of the new Vessel Systems by applying advanced AI techniques (genetic algorithms) and evaluating different hypotheses and scenarios

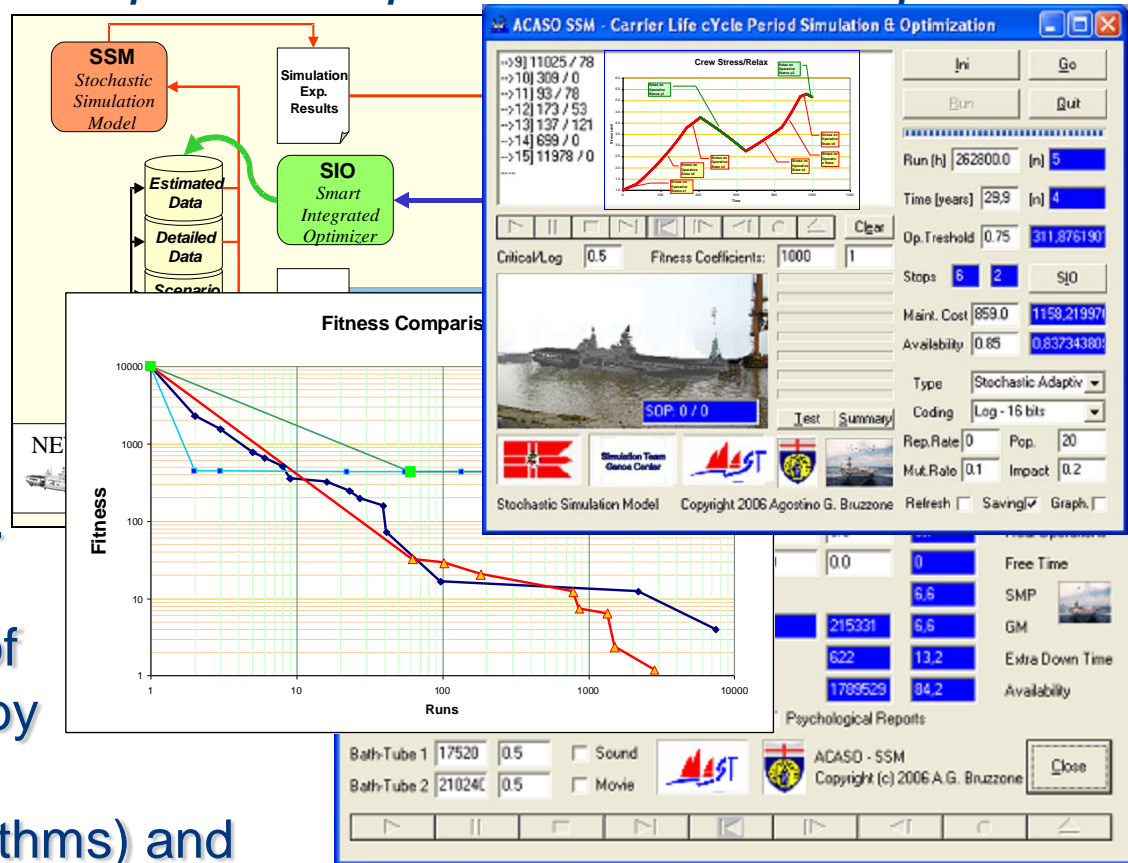



KATRINA LIKE



KATRINA LIKE was a Joint Venture that Demonstrated the possibility to Model a National Crisis and to Simulate a Wide Emergency; the Project successful demonstrated the Simulation of an Hurricane Impact on the Transportation Layers of Louisiana State Considering Traffic Cargo, Evacuation Activities, etc.

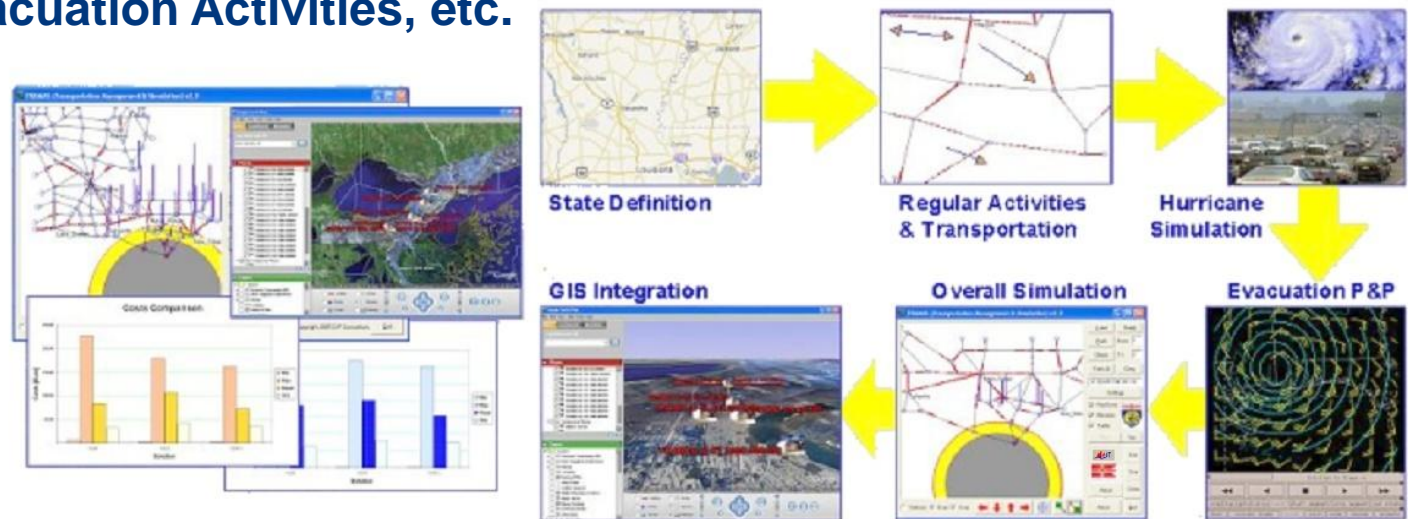



CIPROS

CIVIL Protection Simulator

CIPROS is a modular approach for Civil Protection that integrates GIS and Simulation.

CIPROS generates Crisis Dynamic Web Sites for supporting training and information share

CIPROS includes simulation of:

- Explosions
- Hazardous Material Fallout
- Flooding

CIPROS support definition and management of different Alert Level and Threats Classification as well as evacuation Procedures for Population and people with impediments

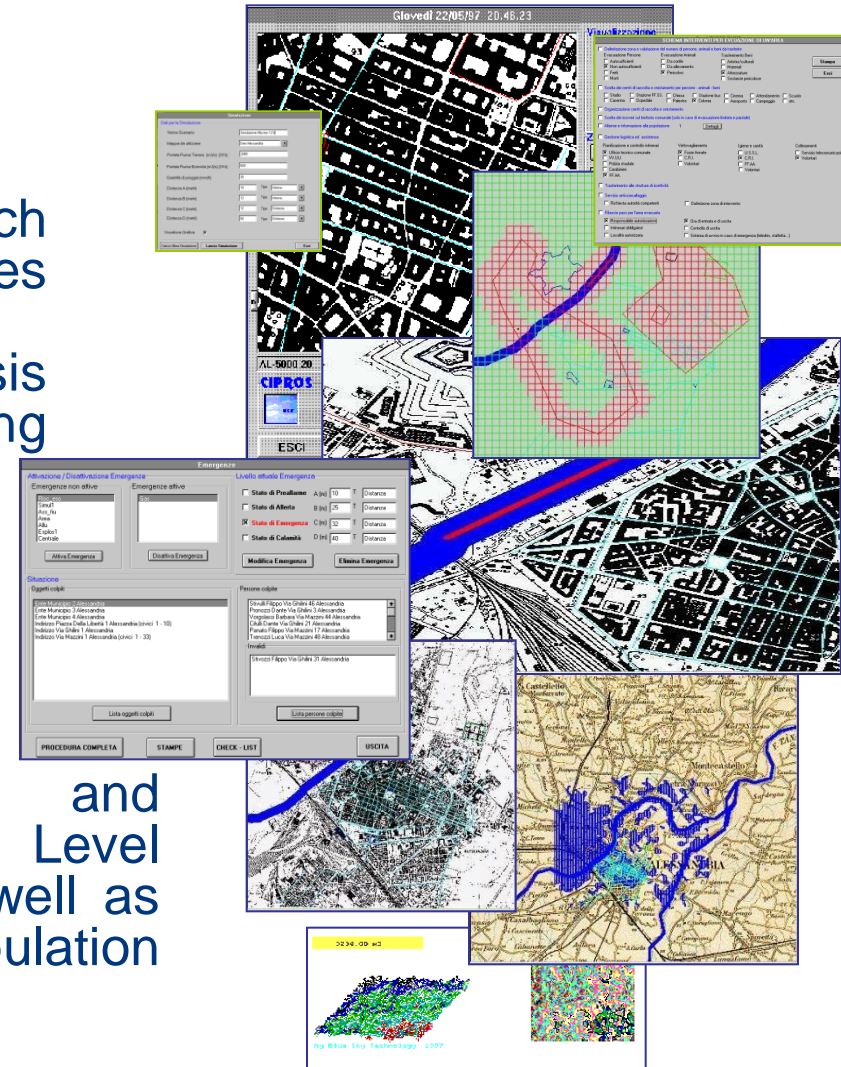



MESA

Maritime Environment for Simulation & Analysis

MESA is an integrated environment to perform simulation and risk analysis in ports and maritime sector.

MESA is devoted to support port organizations, entities and operators in Emergency & Environmental

Management.

MESA is a modular system based on combined simulators running on PC and providing direct output also on WWW servers.

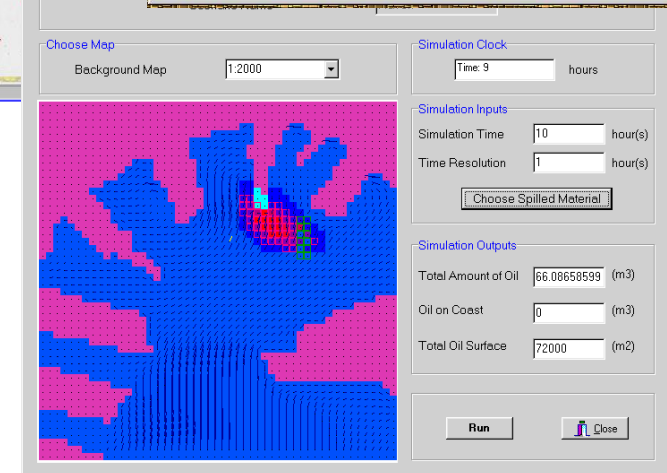
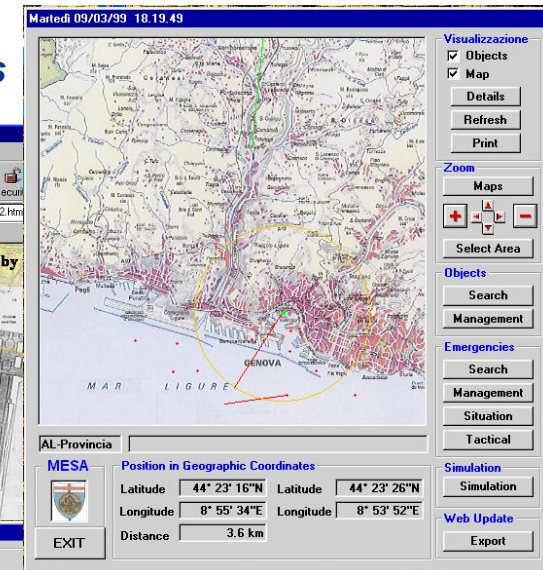
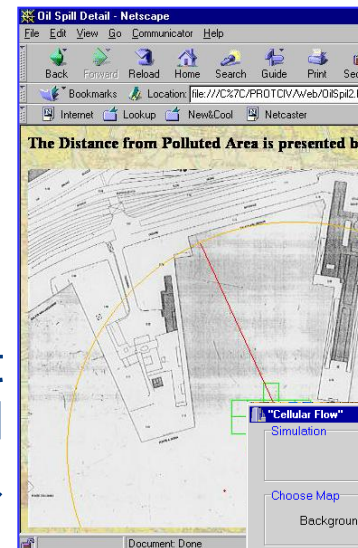



PEDES

PEDEstrian Simulation



PEDES is a Simulation of pedestrian flows in mass transportation (i.e. underground) devoted to support functional analysis, safety and security solution design and analysis; PEDES is integrated with Human Behavior Models

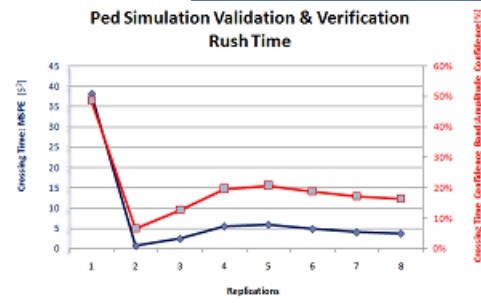
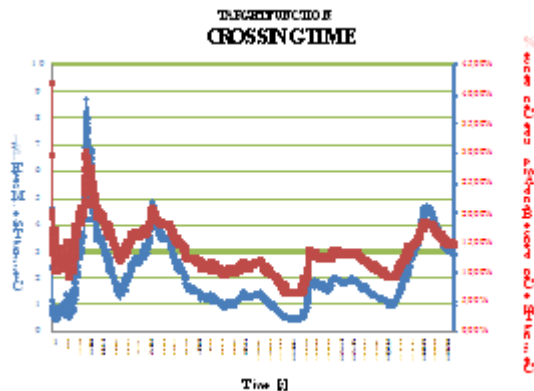
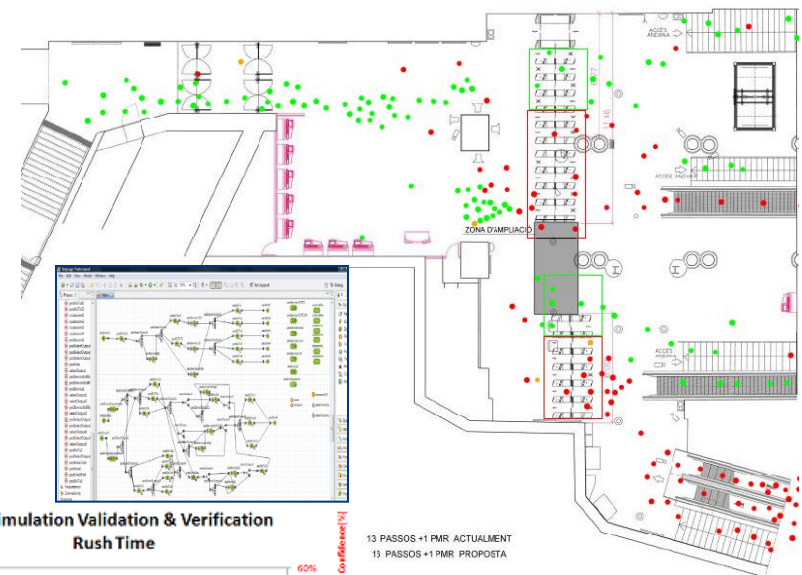

13 PASSOS +1 PMR ACTUALMENT
13 PASSOS +1 PMR PROPOSTA

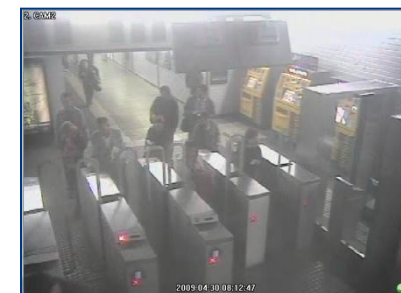



Distributed Virtual Maritime Environment

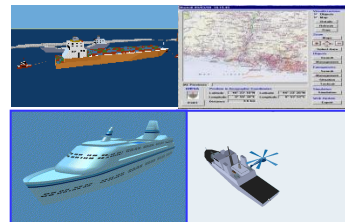

Procedure Design, Risk Analysis , Re-Engineering

C/C++
Java

DIS
HLA

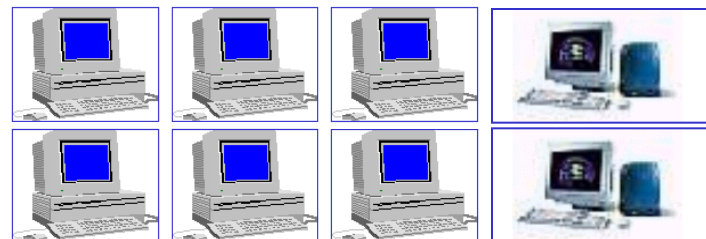
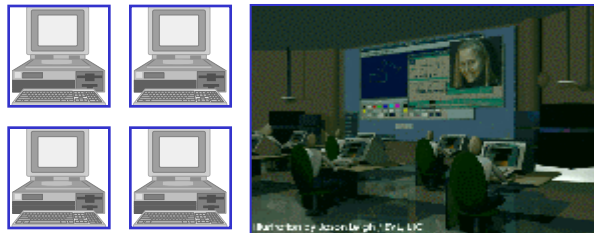

Distributed , Cooperative Planning and Management

Distributed Operation Control

A Platform Independent Distributed Environment for Maritime Applications



FLODAF

Fuzzy Logic Data Fusion

FLODAF is an tools to support engineering and performance estimation of Data Fusion Solution; this suite includes a Scenario Generator and a Simulator for analyzing the Data Fusion performances over complex Air-Naval scenarios including ships, submarines, missiles, airplanes and helicopters.

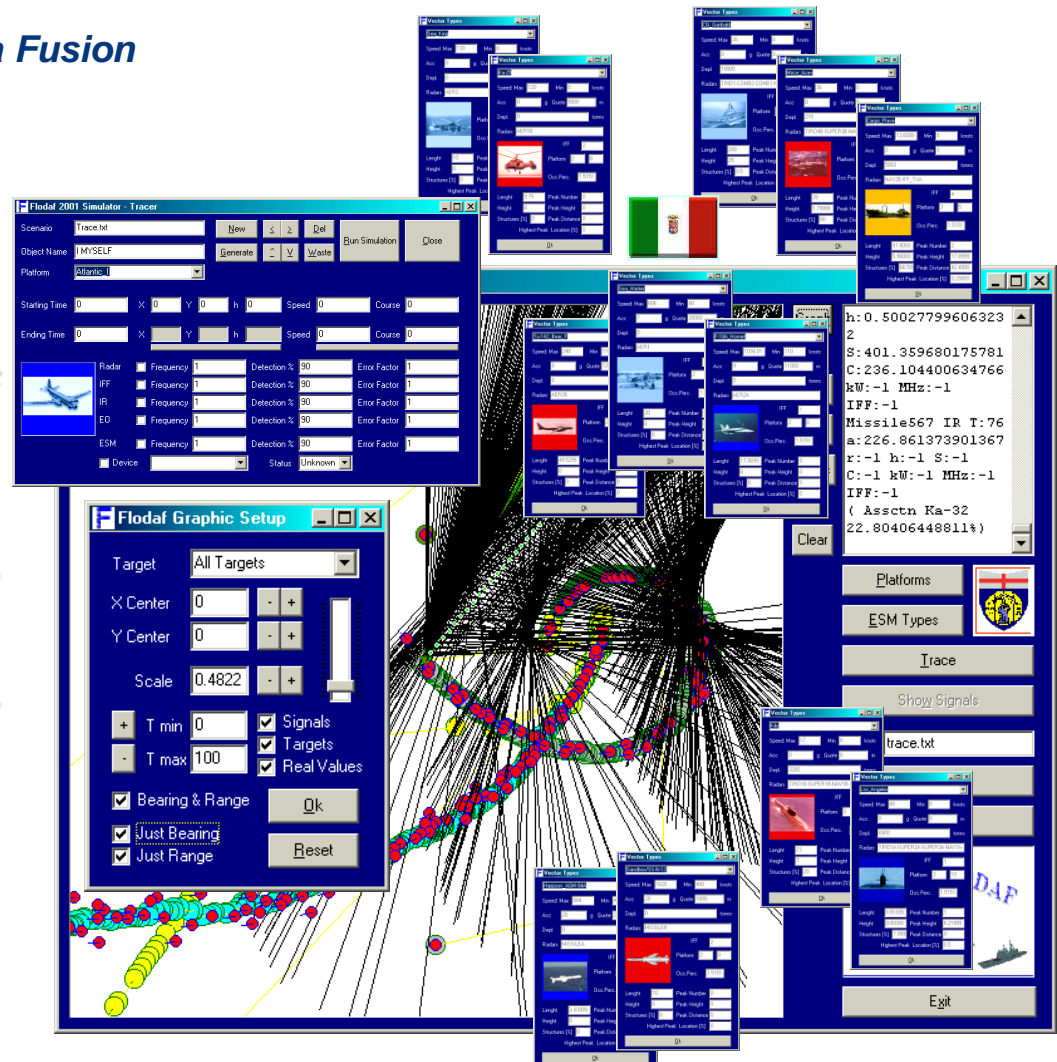



VISION

Virtual Ship Simulation



Orizzonte Sistemi Navali



DIPTM, as reference point in Distributed Simulation and HLA in Italy, was in charge as responsible for defining VV&A procedures in VISION Project devoted to create a Virtual Ship using HLA.

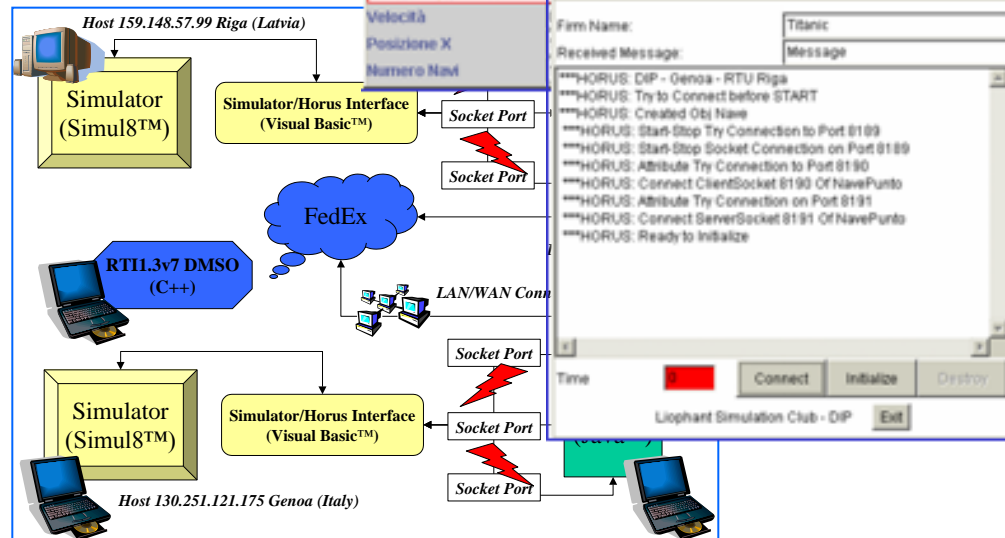
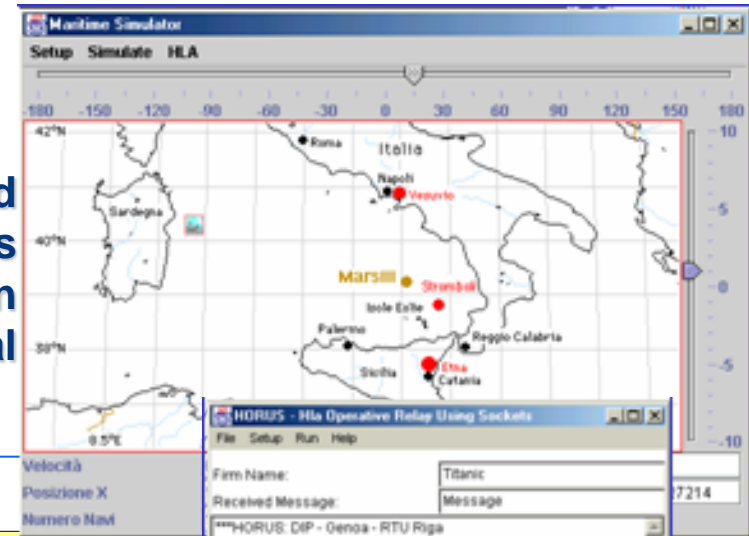



NIAG SG-60

Simulation Based Design And Virtual Prototyping (SBD & VP)



The NIAG SG-60 is devoted to evaluating the effectiveness of SBDVP on Ship Design

The results of the SG60 Study include analysis of Virtual Prototype VV&A procedures, Simulation Based Acquisition impact in terms of saving, costs, resources

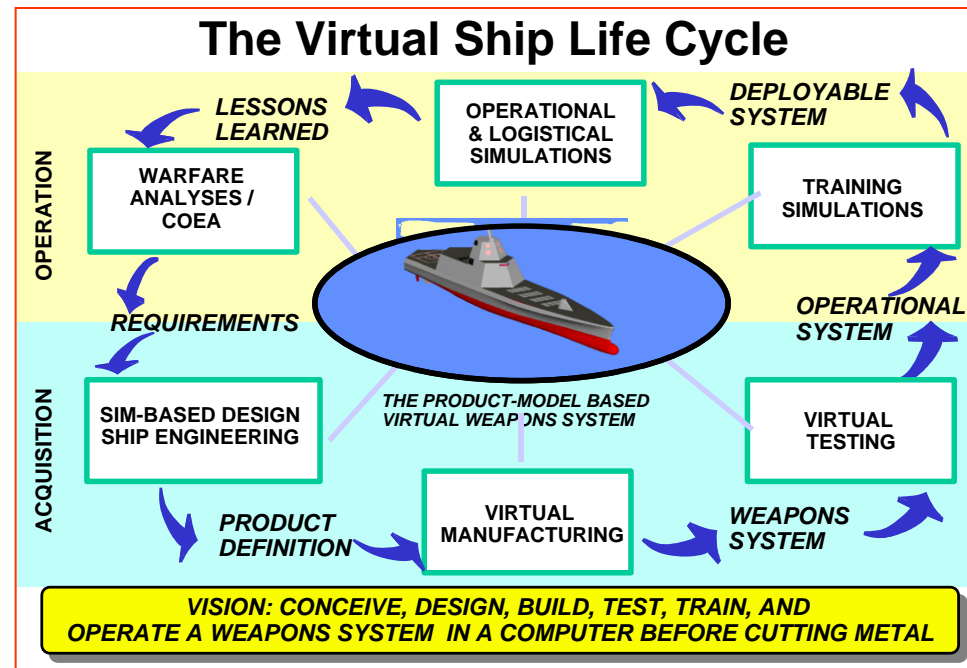



PANOPEA

*Piracy Asymmetric Naval Operation
Patterns modeling for Education & Analysis*

- PANOPEA is a simulator for reproduction of Piracy activities and for evaluating different strategies in NEC C2 M2 (Netcentric Command and Control Maturity Models).
- PANOPEA reproduces military vessels and helicopters, ground base, cargos as well as fisherman and yachts traffic as well as Pirates
- Pirates are directed by Intelligent Agents and apply strategies for succeeding

PANOPEA Command & Control

Network diagram showing connections between entities: LCG, NM2s, NM2s, VMTHQ, VMTHQ, Cargo, Figate_C, Figate_L, Figate_M, Figate_N, Figate_P, Figate_C, Figate_L, Figate_M, Figate_N, Figate_P.

PANOPEA - Piracy Asymmetric Naval Operation Patterns modelling for Education & Analysis

0.636 Overall_Delivery_Success: 0.580 Info_Acc: 0.430 Info_Max: 0.500 Info_Acc_Avg: 0.377 Info_Acc_SoftFail: 0.007 Info_Acc_Max: 1.000 Info_Acc_Avg_Max: 0.003 Cognitive_Domain_Connectness: 0.988 Cognitive_Domain_Connectness_Max: 0.992 Cognitive_Domain_Connectness_Avg: 0.962 Social_Isolated: 182.983 Social_Isolated_Max: 264.003 Social_Isolated_Avg: 116.052 Social_Connect: 1.456 Social_Connect_Max: 1.525 Social_Connect_Avg: 1.549 Pattern_Max: 0.800 Pattern_Avg: 0.616 Overall_Pirate_Captures: 13.000 Overall_Engaged_Pirates: 22.000 Overall_Costs: 3.175 Overall_Workload: 0.492 Overall_Visibility: 0.004 Overall_Resilience: 3.153 Overall_Responsiveness: 63.234 Overall_Flexibility: 0.967 Overall_Effectiveness: 1.808

Buttons: Load, Run, Show, Hide, Quit

Dynamic GIS, GIS On, Time: 9 (day) 23:54:20:20

Copyright (c) 2009-2012 Simulation Team MISS DIPTTEM Genoa University

PANOPEA

Total Attacks: 7, Pirates Successes: 4, Crossings: 202852, Flow: 46.8218003

Helicopter: Average Setup Time [h]: 0.1, Radar max [Nm]: 45, Eye Max [Nm]: 12, Speed [Knots]: 135, Max Distance to Try [Nm]: 240

Fisherman Boat/Pirates: Generate [boats]: 700, Pirates [%]: 3, Attack Threshold [Nm]: 8, Attack Probability [%]: 0.8, Fisher Speed [Knots]: 10, Pirate Speed [Knots]: 35

Intelligence Detection Probability: 0.1



WSS&S

Weapon System Service & Simulation

This Simulator is devoted to re-engineer Weapon System Logistics and Service.

The Simulator is operating in Taranto Base to support the service planning of Torpedo, Missile, Rocket Launchers and Naval Gun Systems.

The simulator is a web-based stochastic simulator and supports the concurrent service management; the model is object-oriented and the implementation allows to operate directly with regular browsers without any special requirements in term of platform or plug-ins..

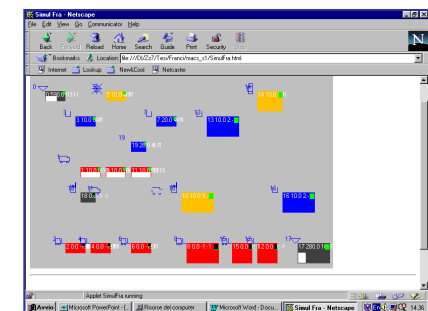
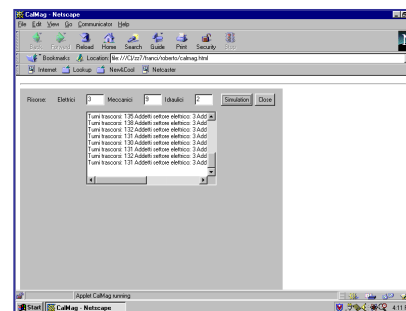
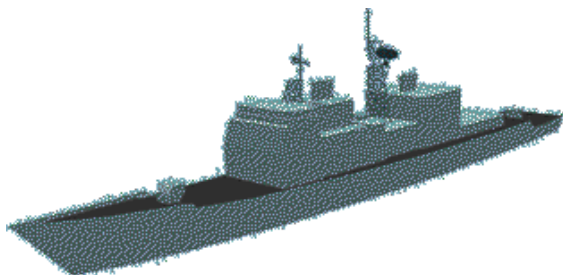



SAFETY FIRST

Training & Design for Ship Handling

The simulator includes a complete virtual reproduction of Genoa Harbor and it's devoted to the design and training of Harbor Technical Services Operators (Pilots, Tugs & Boat Men)

This simulation system is designed in order to be portable for cooperative training on web server just using regular browser with specific plug-in.



- *Full Interactive Real-Time for Training*
- *Faster than Reality for Procedure Design*
- *Virtual Environment of Genoa Port on a PC*



SESTANTE

Simulation Environment for Ship Traffic Analysis, Testing & Evaluation

The project supports the simulation of Maritime traffic in a wide area (i.e. Mediterranean Sea) by using Object Oriented Models.

SESTANTE allows to compute the flows and delays related to strategic investments over ports or maritime lines.

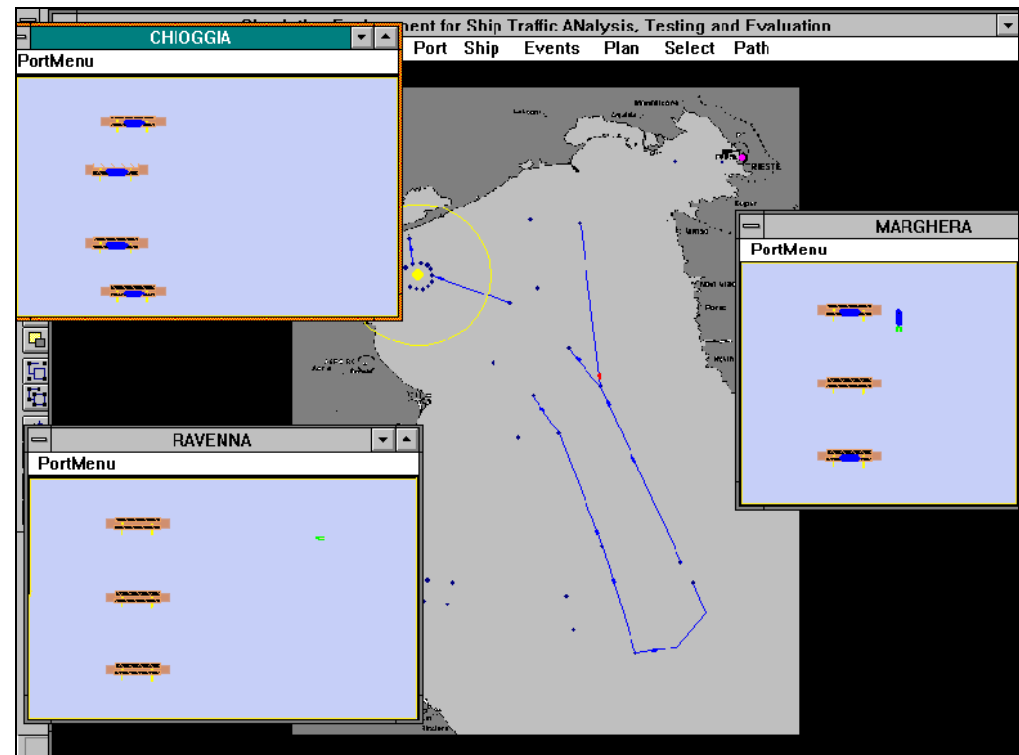
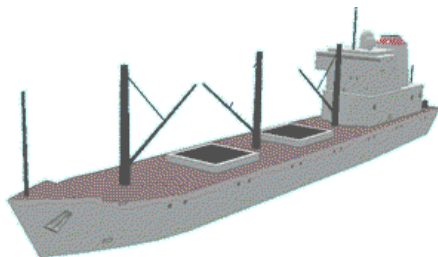



ROSES

Reaction to Oil Spill Emergency and Simulation

The project is devoted to create an Oil Spill Simulator for CETENA including countermeasure models.

The Simulator was validated in relation to historical data available from previous cooperations (i.e. MESA, Kuwait University, etc.) and existing databases (i.e. Istituto Idrografico Italian Navy) in order to guarantee the result fidelity.

Roses reproduces both the oil spill physical phenomena and the countermeasures actions in order to provide estimations about risks, policy effectiveness and standing operating procedures.

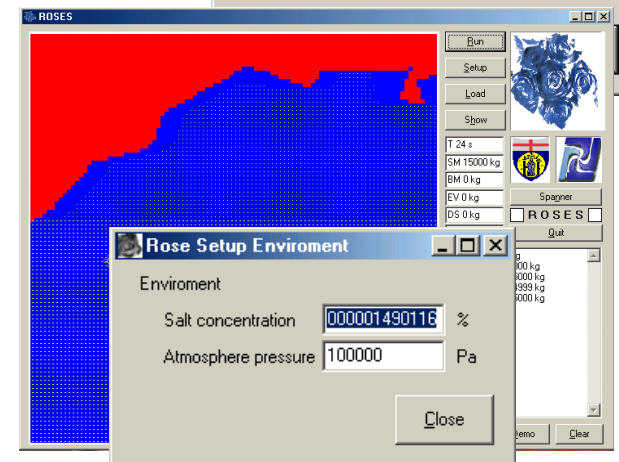
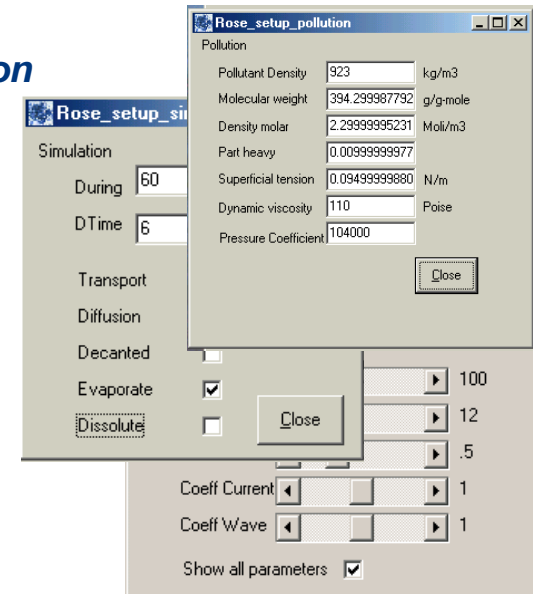



POSEIDON

Port Simulation Environment for Design of Operation and Network

This Project involves a web based, stochastic & combined (discrete & continuous) simulator.

- **Multedo Oil Terminal Genoa**
- **Vessel Traffic System**
- **Tankers**
- **Docks**
- **Pilot Boat**
- **Tugs**
- **Mooring Men Boats**

Demo is available at:

www.itim.unige.it/liophant/projects/poseidon

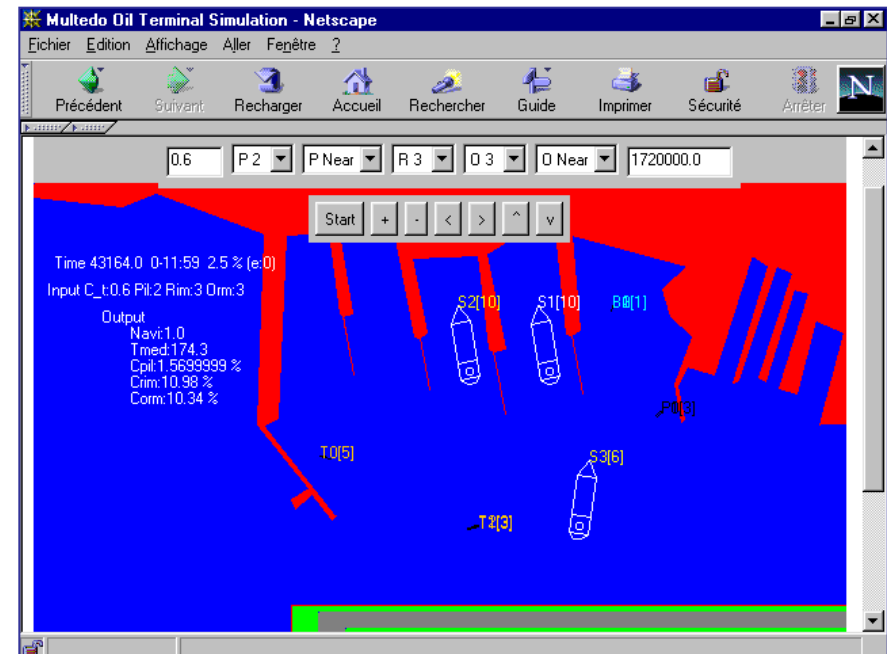



SIMILO

Ship MicroLogistics

The simulator *Similo* (Ship MicroLogistics), is an integrated approach to M&S and VR devoted to support on-board plants and processes; in this case the study focused on the crew mensa (cook-room) in development by CETENA/Fincantieri.

Similo model the interaction among people and his behavior in order to estimate support performance analysis (i.e. evaluation of external catering as substitute of kitchens in Fast Ferries).



Java
Javascript
3DSMax

Vbasic
Maxscript
HTML



Placra

Platform Crew Analyser

The Placra model was developed in order to reproduce the crew activities on Oil Platforms. Placra simulates crew activities

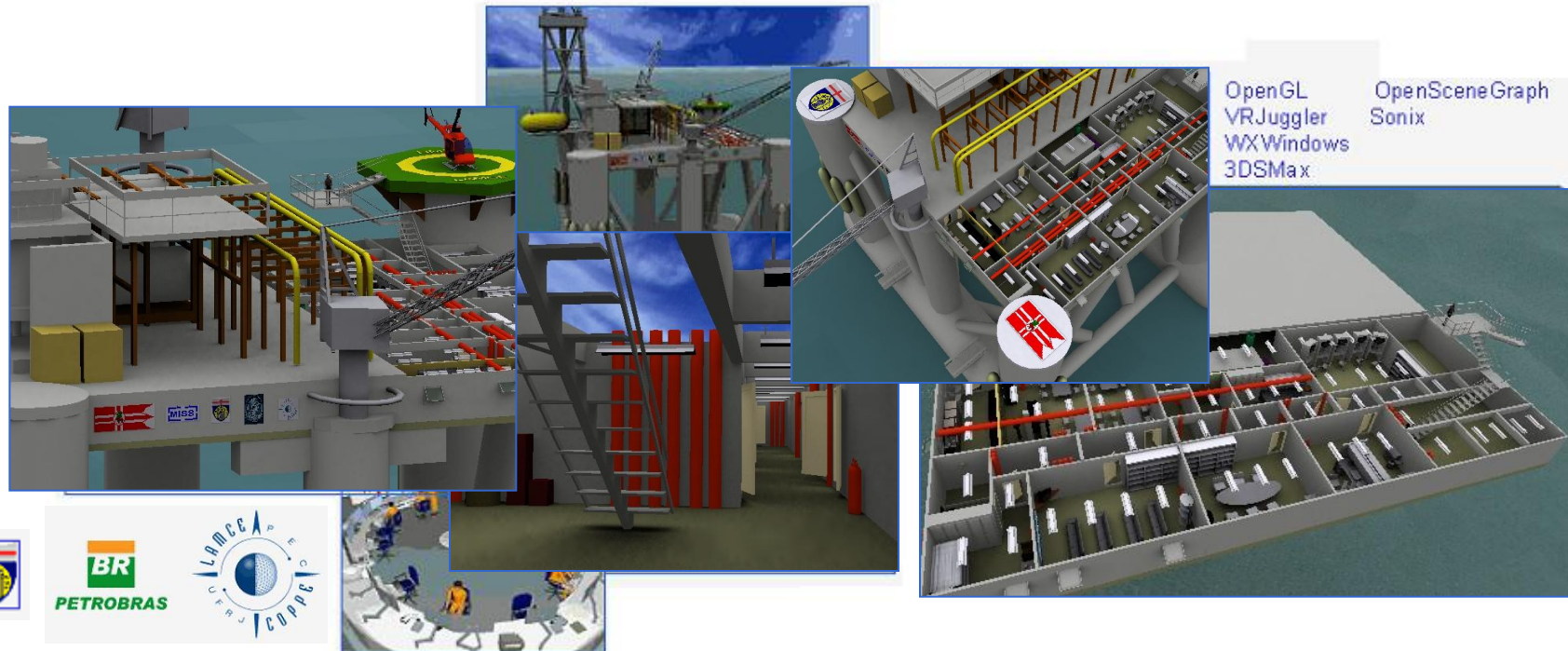

OpenGL
VRJuggler
WXWindows
3DSMax
OpenSceneGraph
Sonix





DESU-BUMATRAS

Development Support for Front & Design in Bulk Material Transhipment System

DESU-BUMATRAS provided support to the development, validation of a Stochastic Discrete Event Simulator and on the related analysis on a Bulk Material Terminal & Transhipment Solution involving sea vessels & river barges

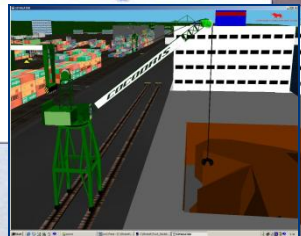



CYBERSAR Portainer Simulator

Cyber Infrastructures for R&D in Sardinia-Portainer Simulator

Portainer Simulator developed
as further evolution of DIPTTEM
Engine (Cocodris)
by using ST_VP.

The System is devoted
to Support Training and
Virtual Prototyping by
integrating Simulation
and Biometrics Device

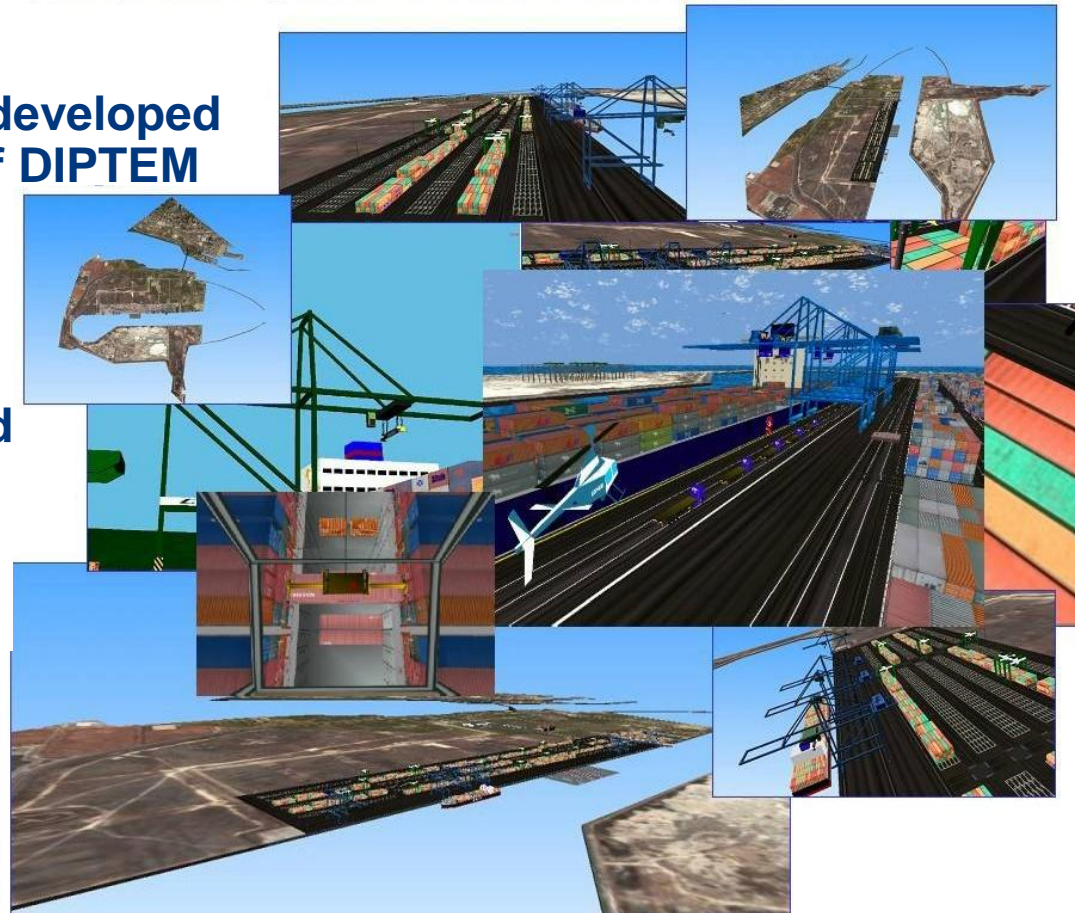



VIP-STRALO

Virtual Prototype by Simulation in Transportation and Logistics

VIP-STRALO goal is the creation of an innovative solution based on Interoperable Simulation for SBDVP (Simulation Based Design and Virtual prototyping) applied to Logistics, Transportation and Automation Sectors.

VIP-STRALO included the creation of two interoperable demonstrators:

- **LOCRAS: Logistics Crane Simulator**
- **FEBO: Federation of Boats**

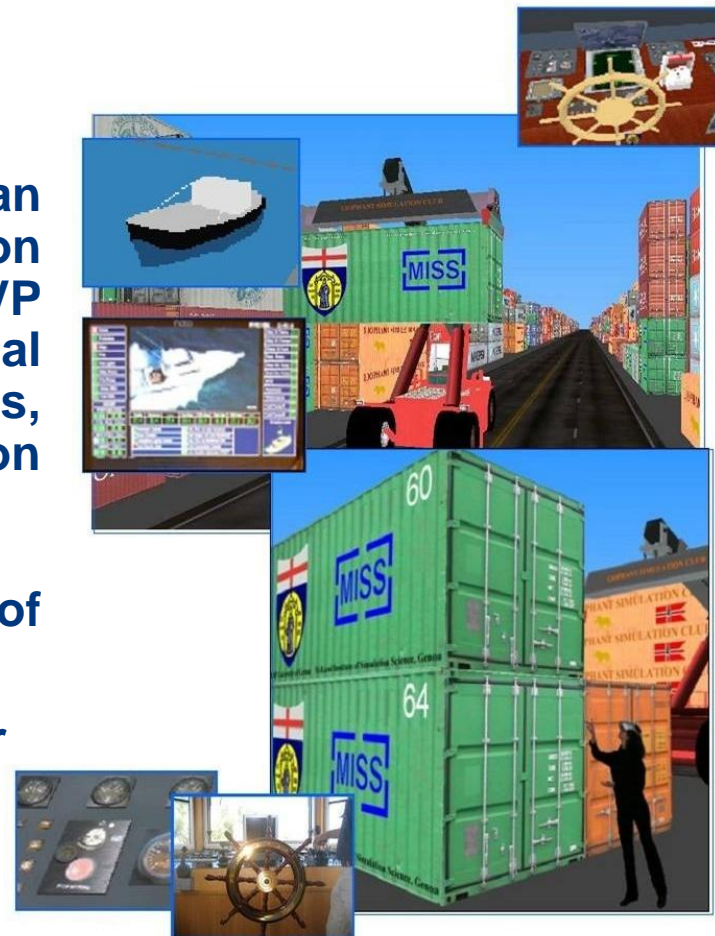



ProSim

Project Management Simulation System

The project is a joint venture between Genoa University and Fincantieri, the major Italian Ship Yard Construction Company.

The project was tested in relation to their new generation of commercial ships: fast ferries for the car deck systems involving impact of R&D and prototyping issues.

ProSim has been already successfully applied to traditional ship construction problems for military ships and now is fully integrated with existing Project Management Software

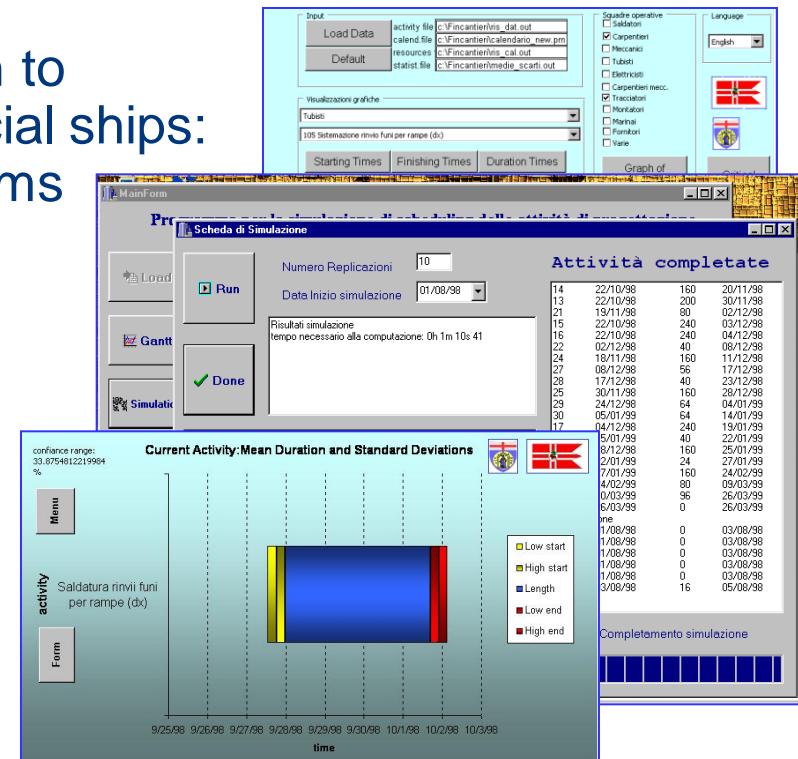



ST_PT & ST_RS Simulators

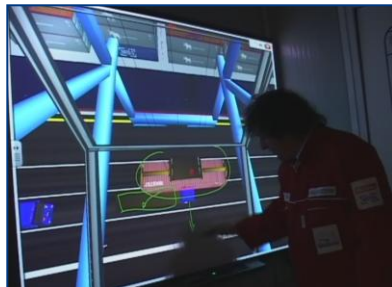
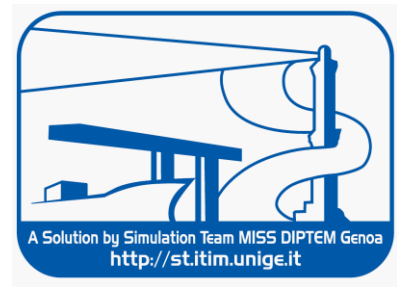

This new generation of simulator is mobile, real-time, scalable and interoperable and compliant with state of art technology and standards

Shelter & Facilities

ST_PT Crane Sim

ST_PT Truck Sim





Atout of our Virtual Simulation



Training & R&D



Cave H270° V130°



Containerized

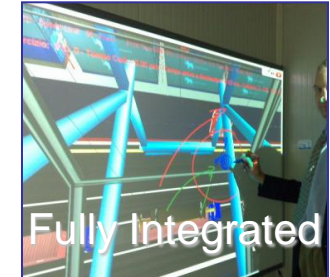

Fully Integrated

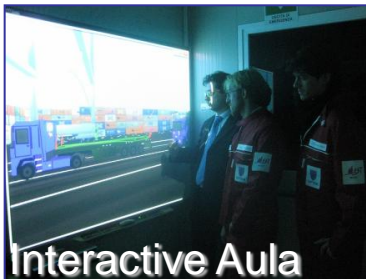

Interactive Aula



On-Line
Action Review



HLA Federation



Full Motion,
Sound
& Vibrations



Real-Time
Distributed
Simulation



Bio-measures
Integrated in
Simulation



Strong
VV&A



Scalable
Solutions





ST_VP: Virtual Port Simulation



The **ST-VP** is the ultimate Port Crane Simulator developed by Simulation Team and includes all the different crane types and New Solutions for Operator Training, Safety and Security, Procedure Definition, Equipment Design and Virtual Prototyping



ST-VP is fully containerized real-time distributed HLA Simulator reproducing Port Operations. ST-VP is integrated in a 40' High Cube Container ready to be used on site immediately after arrival.

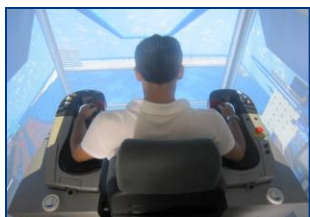

ST-VP Simulator allows to operate all the different Port Cranes in a Virtual World by an immersive Cave (270° Horizontal and 150° Vertical), reproducing Sounds, Vibrations, Motion in all weather conditions

ST-VP includes a Full-Scope Simulation for Training Operations & Procedures, an Integrated Class Room, the Instructor Debriefing Room, and secondary Interoperable Simulators of all the Port Cranes and a Biomedical Module for Safety, Ergonomic and Posture Enhancement.

ST-VP World is customizable for each Port, Crane & Procedure and Equ





ST_VM: Virtual Marine

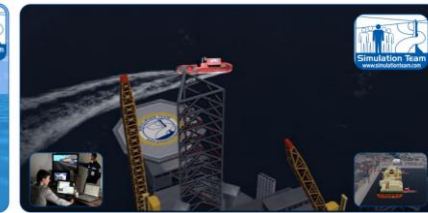
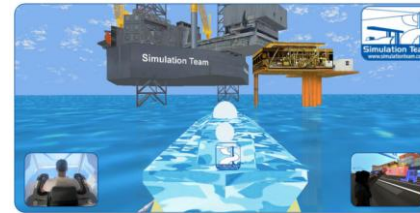

The ST-VM is the ultimate Marine Simulator developed by Simulation Team and includes many different Marine components, equipment and platforms as well as New Solutions for Terminal Design, Operator Training, Safety and Security, Procedure Definition, Equipment Design and Virtual Prototyping



ST-VM is fully containerized real-time distributed HLA Simulator reproducing Port Operations. ST-VM is integrated in a 40' High Cube Container ready to be used on site immediately after arrival.



ST-VM Simulator allows to operate all the different Marine Devices in a Virtual World by an immersive Cave (270 ° Horizontal and 150° Vertical), reproducing Sounds, Vibrations, Motion in all weather conditions

ST-VM includes a Full-Scope Simulation for Training Operations & Procedures, an Integrated Class Room, the Instructor Debriefing Room, and secondary Interoperable Simulators of different Marine equipment with other modules (i.e. Biomedical Module for Safety, Ergonomic and Posture Enhancement).

ST-VM World is customizable for each Platform, Port, Crane, Procedure and Equipment.





ST_PT: Port Crane Simulation

The ST-PT is the Gantry Crane Simulator developed by Simulation Team and represents a New Solution for Operator Training, Procedure Definition, Equipment Design and Virtual Prototyping

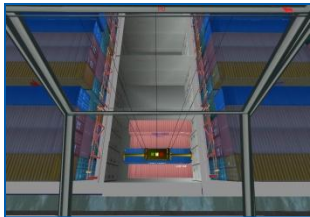

ST-PT is fully containerized real-time distributed HLA Simulator reproducing Port Operations. ST-VP is integrated in a 40' High Cube Container ready to be used on site immediately after arrival.

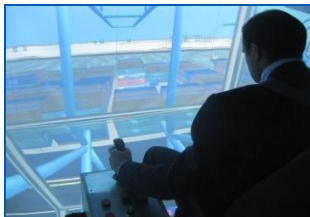

ST-PT Simulator allows to operate Port Cranes in a Virtual World by an immersive Cave (270 ° Horizontal and 150° Vertical), reproducing Sounds, Vibrations and Motion and all weather conditions



ST-PT includes a Full-Scope Simulation for Training Crane Operations & Procedures, an Integrated Class Room, the Instructor Debriefing Room, and secondary Interoperable Simulators of Trucks and Other Cranes, Biomedical Module for Ergonomic and Posture Enhancement.

ST-PT World is tailorable for each Port, Crane & Procedure and Equipment.





SPM

Smart Polygeneration Micro Grid

SPM is a 7.1M€ EU project devoted to manage efficiently and economically the whole UNIGE SV Campus systems optimizing contributions coming from renewable sources. SPM is equipped with a grid monitoring system for grid, in charge of checking the functional status of all elements. SPM also includes control and Optimization, consumption forecasts, Operation planning and real time control of the grid exchange, by regulating generation and consumption units. Sources include: a photovoltaic plant, three solar thermodynamics units and three trigeneration micro-turbines, two natural gas boilers, refrigerating and absorbing plant and electrochemical/thermal storage





ST_RS: Truck Simulation



The **ST_RS** is an Innovative Interoperable Truck Simulator fully integrated with **ST_PT** and Virtual Port; it provides opportunities for Training, Operative Planning and Terminal Procedure Redesign and Re-Engineering

ST_RS is fully containerized real-time distributed HLA Truck Simulator with Port & Inland Terminal and External Scenarios. **ST-RT** is integrated in a 40' High Cube Container ready to be used on site immediately after arrival.

ST_RS Simulator allows to operate Trucks in Terminal and over External Roads within a Virtual World by an immersive Cave (270 ° Horizontal and 130° Vertical), reproducing Sounds, Vibrations and Motion.

ST_RS includes a Full-Scope Simulation for Training Truck Driving, Logistics Procedures, an Integrated Class Room, the Instructor Debriefing Room, and secondary Interoperable Simulators of Different Cranes Cranes, Biomedical Module for Ergonomic and Stress Level Enhancement.

ST_RS World is tailorable for each Terminal Scenario, Truck, Procedure and Equipment.





CTrain

Serious Games to Train Operators into Military Logistics for Overseas Operations



CTRAIN is a serious game devoted to train Operators into Military Logistics for Overseas Operations. CTRAIN is project developed in cooperation by MSC-LES, CAL-TEK and University of Genoa under the umbrella of the Simulation Team.

CTRAIN makes use of interoperable simulation for providing its user with a distributed virtual environment in which different types of operators can be trained with cooperative sessions.

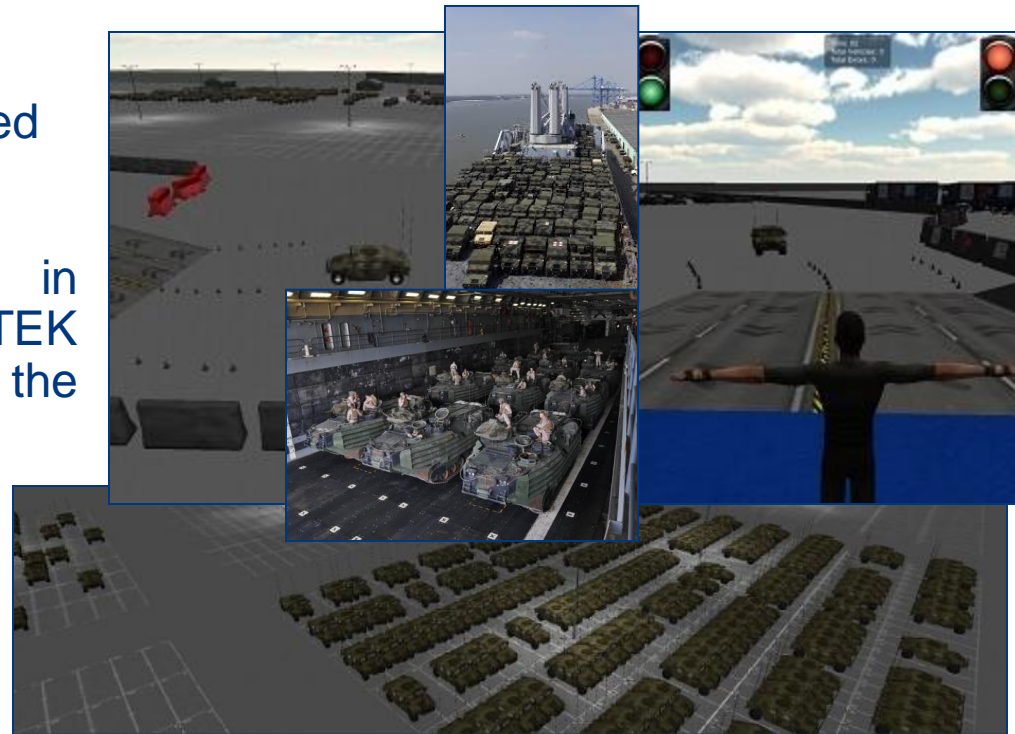

www.sim4future.com/cloud_1.html



CTSim

Serious Game for Ro-Ro Operations



CTSIM is a research project developed by MSC-LES, Genoa Univ, CAL-TEK under the umbrella of Simulation Team. CTSIM can be used to train operators working in car terminals with particular attention to drivers, marshalls, quality checkers and tally men.

The CTSIM architecture is based on interoperable simulation and makes use of dedicated external hardware (i.e. motion controllers, virtual immersive helmets, wheel, pedals, etc) to provide users with the sensation to be in a real car terminals.

Multiple scenarios are available in terms of different terminal layouts (based on real existing terminals), multiple vehicles (i.e. cars, trucks, buses, etc.) and multiple types of available operators.



www.sim4future.com/cloud_1.html



DEMON

DEsign of port facilities for boat Manufacturing Operations in the Nautical sector

A business plan for correctly designing a port facility devoted to manufacture and store boats has been developed. The business plan starts with the analysis of the International and National shipbuilding markets and then narrows down to the Calabria Region one. All the port facilities within Calabria have been analyzed and evaluated; this analysis has brought to the correct identification of the optimal location for setting up the port infrastructure. The port plant layout has been designed and economic and financial analysis have been carried out.





RESET

River Equal Ship Simulation in Extensive Training

RESET is a project, devoted to creating a Federation for supporting training in river navigation and logistics. The Simulators includes:

- Barges
- Tanks

The RESET Federation includes the river dynamics for reproducing the maneuvering in condition affected by different streams, variable deep.



STICEL



Log.In.Form.





INNOVARE

Sviluppo Intermodale Novara e Vercelli Abilita' Risorse Umane - Equal

INNOVARE is a project, devoted to creating a Federation for supporting cooperative and competitive training in hinterland terminals. The Simulators includes:

- Reachstacker Simulator
- Truck Simulator
- Transtainers

The INNOVARE Federation is centered on the Rail Terminal Simulation and CM operations.



STICEL

Log.In.Form.



autovictor



Virtual Prototyping



The Simulation Team Solutions are very effective as support for Virtual Based Design and Prototyping measuring Real Overall Performances in the Virtual World by considering dynamic interactions among all the Elements and Entities.

Experience was carried out in Equipment, Control and Man-Machine Interface Re-Engineering

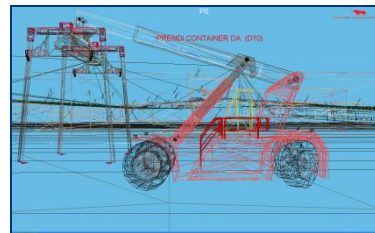
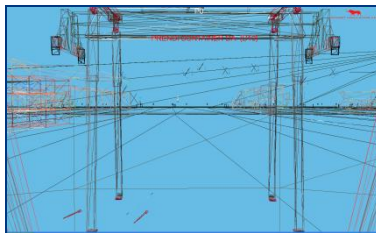



SITRANET

Simulation for TRAINiNg & Education in Transportation

SITRANET is a project sponsored by EC, devoted to creating three simulators as training equipment for crane operators based on Virtual Reality.

The Simulators includes:

Special Crane Simulator
 Contstacker Simulator
 Truck Simulator

The project technology leadership is assumed by DIPTTEM. The SITRANET Simulator validation and verification involved over hundreds professional truck drivers and crane operators



McLeod Institute of Simulation Science, Genoa



McLeod Institute of Simulation Science, Genoa

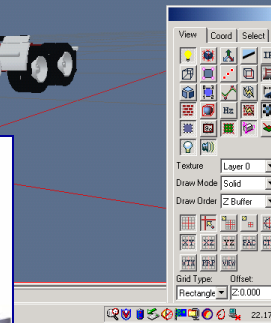



Virtual Degenerative Operator Conditions

Simulation Team Solutions is proposing to start up a new project for Modeling the Degenerative Perception of Humans in Critical Conditions combining Simulation and Biomedical Measures. The Goal is to reproduce the Operator Perception under high stress or fatigue, or upon drug/alcohol abuse for creating a Virtual Framework devoted to develop possible MMI Aids and support definition of policies and regulations





Virtual Security Assessment and Training



VISAT (Virtual Security Assessment and Training) allows to Simulate Security Issues in Complex Framework such as that one related to Port Environments.

VISAT includes Constructive Sim of organizations and layouts as well as Synthetic Environment for Virtual Sim supporting Distributed Cooperative Training among different Actors (i.e. Port Authority, Coast Guard, Custom Resources, Terminal Operators, Public Urban Authorities) within different Scenarios

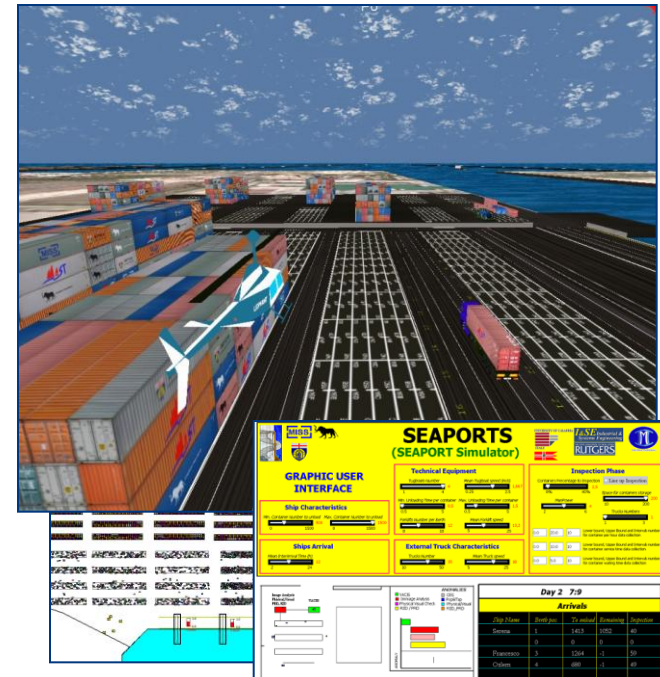



Port/Terminal Security Simulation



Simulation Team is active in Modelling & Simulation for Guaranteeing Security in Maritime Environment especially in reference to Ports and Terminals

A major goal in this context it is to create solutions that support the Definition of operative and training procedures for security and safety harbours operations with strong emphasis on common standards and multi user framework

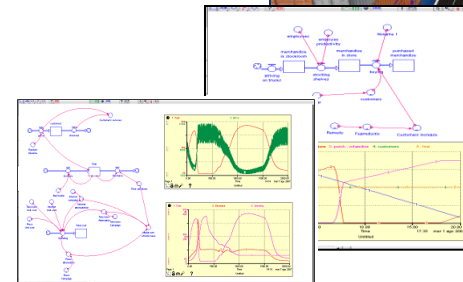



GreenLog Simulators



Simulation Team developed GreenLog Simulators for Analyzing Production, Logistics and Supply Chain.

GreenLog is a Web Based Simulation Engine devoted to evaluate Costs and Environmental Impacts of Productive, Logistics and Transportation Elements of the Supply Chain and Specific Modules have been developed for focusing on specific aspects:

- GreenLog Port
- GreenLog Ship
- GreenLog Crane
- GreenLog Warehouse
- GreenLog Train
- GreenLog Air
- GreenLog Heavy Haul

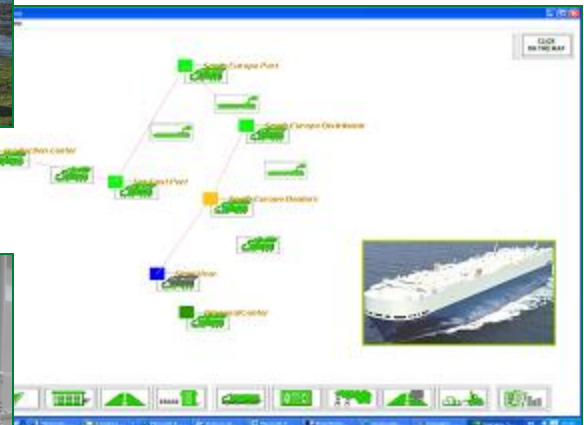



GREENLOG Project

Green Logistics Project

GreenLog is a web framework combining simulation and analysis techniques for self evaluating the Supply Chain efficiency in term of Costs, Quality and Environmental Impact. The GreenLog was developed by Simulation Team DIPTM for supporting a Joint Venture on Green Logistics coordinated by Assologistica in cooperation with several major production, logistics and distribution companies operating in Italy



Cultura e Formazione
Assologistica

CAMPARI

Mars

SONY

CRAI

coop

DHL



20



GREENLOG Port

GreenLog Port Simulator



GreenLog Port is a specific Simulation Module devoted to support estimation of Environmental Impact in Ports

- Garbage & Port Waste
- Dredging
- Dust
- Noise
- Ship Air Emissions
- Air Quality
- Hazardous cargo
- Bunkering
- Port development
- Ship Discharge

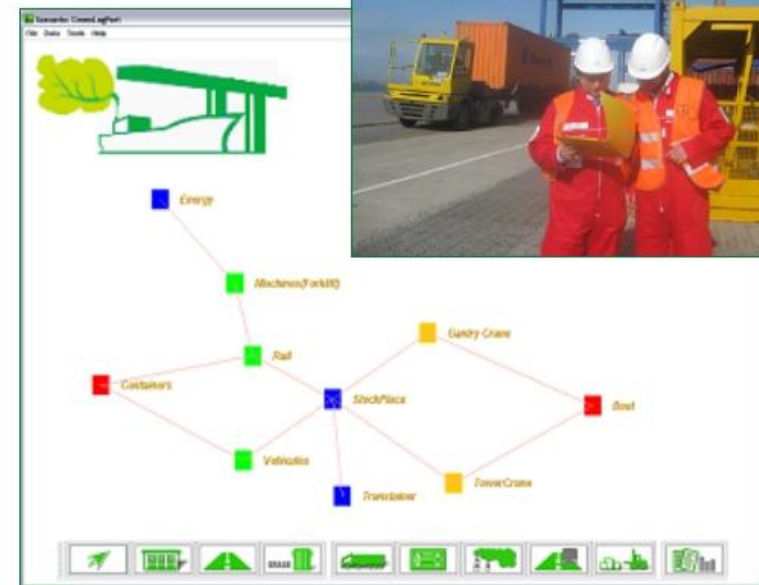

*Developed in Cooperation
with Simulation Team & DIPTM*





GREENLOG Ship

GreenLog Ship Simulator

GreenLog Ship is a specific Simulation Module devoted to analyze the Environmental Impact of the Ship for supporting monitoring, alternative evaluation, saving and benefits from different solution in use, handling, operating as well as in Ship Design GreenLog Ship Includes Air Emission, Consumption, Ship Paints, Garbage/Waste Disposal, Noise, Ship Discharges, Hazardous Cargo, Spills

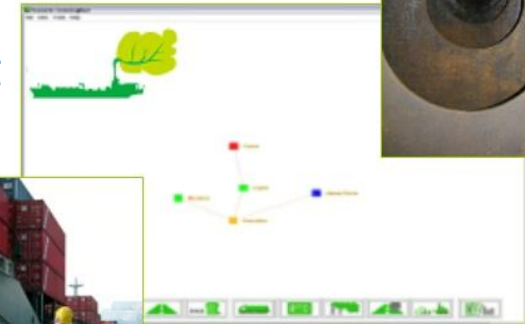

*Developed in Cooperation
with Simulation Team & DIPTM*





GREENLOG Crane

GreenLog Crane Simulator



GreenLog Crane is a specific Simulation Module devoted to analyze the Environmental Impact of Cranes and Handling Devices considering Operative Costs and Environmental Impact. GreenLog Crane allows to estimate the benefits provided by innovative solutions in terms of power saving, oil spill reductions, better safety procedures and higher performances.

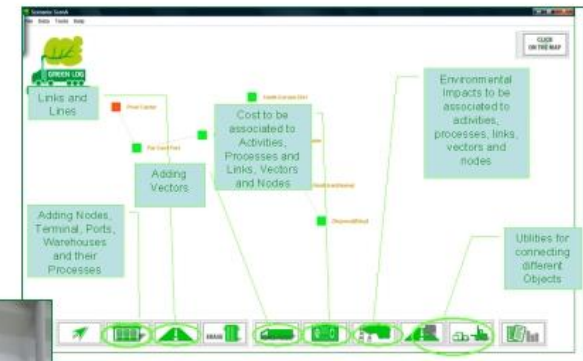

*Developed in Cooperation
with Simulation Team & DIPTM*





GREENLOG Heavy Haul

GreenLog Heavy Haul Simulator



GreenLog Heavy Haul is a specific Simulation Module devoted to analyze the Environmental Impact of Trucks and Heavy Hauls considering Operative Costs and Environmental Impact

GreenLog Heavy Haul allows to estimate the benefits provided by innovative solutions in term of oil and gas consumption, tires, better safety procedures and higher performances



*Developed in Cooperation
with Simulation Team & DIPTM*





GREENLOG Warehouse

GreenLog Warehouse Simulator



*Developed in Cooperation
with Simulation Team & DIPTeM*

GreenLog Warehouse is a specific Simulation Module devoted to analyze the Environmental Impact of Warehouse and Logistics Platforms considering Operative Costs and Environmental Impact. GreenLog Warehouse allows to estimate the benefits provided by innovative solutions in term of reefer solutions, infrastructures, power generation, handling devices & equipment, management policies and control systems.

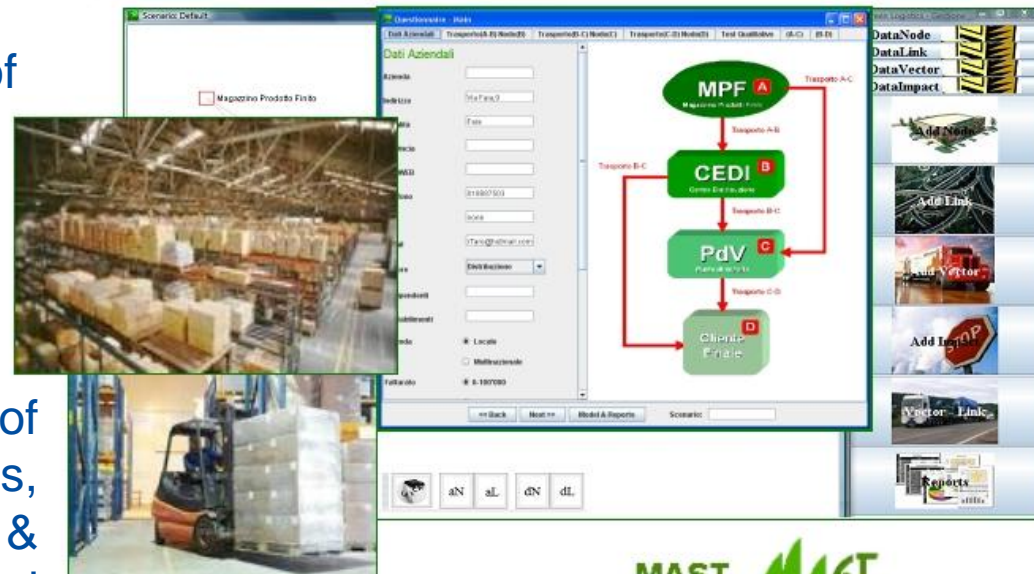



GREENLOG Train

GreenLog Train Simulator



GreenLog Train is a specific Simulation Module devoted to analyze the Environmental Impact of Railways and Trains considering Operative Costs and Environmental Impact. GreenLog Train allows to estimate all the different direct and indirect environmental impacts as well as the benefits from innovative solutions in term of power saving, waste reductions, better safety procedures and higher performances.



*Developed in Cooperation
with Simulation Team & DIPTM*



GREENLOG Air

GreenLog Air Simulator

GreenLog Air is a specific Simulation Module devoted to analyze the Environmental Impact of Airports and Planes considering Costs and Environmental Impacts both of commercial and cargo operations. GreenLog Air allows to estimate all the different direct and indirect environmental impacts as well as the benefits from innovative solutions in term of management policies, power saving, consumption reduction, waste reductions, safety & security procedures and higher performances



*Developed in Cooperation
with Simulation Team & DIPTM*





LAPIS

Lean Advanced Pooling Intelligent optimizer & Simulator

LAPIS is an intelligent decision support system for Service Division of Construction and Engineering Companies. LAPIS combines different modules:

- Service Model
- Inventory Optimizer
- Scheduling Optimizer
- Overall Resource Optimizer
- Metrics & Key Performance Indexes

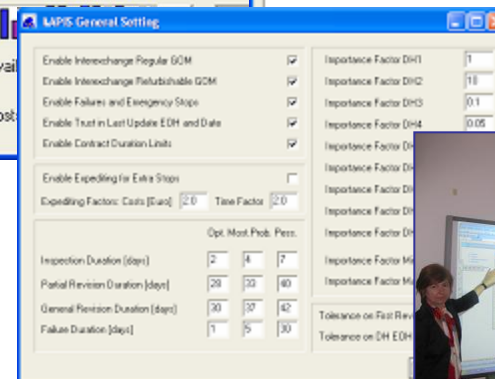
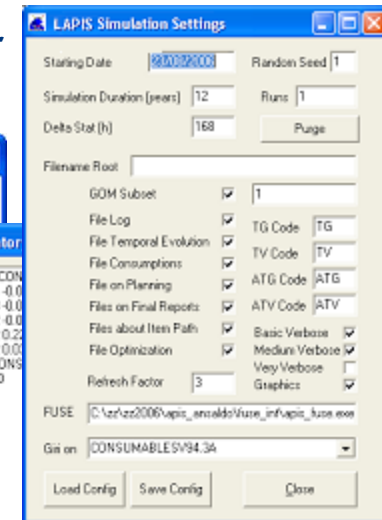
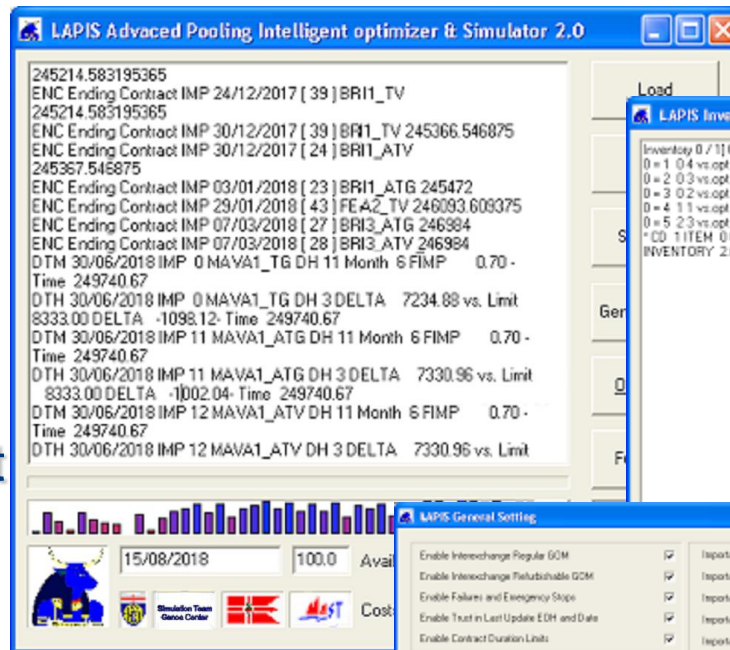



LEXIS

Layout Excellence Integrated Simulation



*Developed in Cooperation
with DIPTEM University of Genoa*

LEXIS (Layout Excellence Integrated Simulation) integrates **Layout Optimization** based on **Genetic Algorithms**, **Modeling & Simulation** and **Virtual Reality**. LEXIS was applied with success to new large **Production Facility** for **Aerospace Industry**. The system allows to consider **costs**, **distances**, **times** and all different **production processes** and **internal and external logistics solutions**





LEXIS for Constructions



LEXIS (Layout Excellence Integrated Simulation) represents a solution for Optimizing Space, Planning and Operations in Constructions even considering the sequence of actions and the use of the equipment on the Construction Yard.



Developed in Cooperation
with Simulation Team & DIPTM



LEXIS for Ship Yard Constructions



LEXIS (Layout Excellence Integrated Simulation) represents a solution for **Optimizing Space, Planning and Operations in Ship Yard Constructions** as well as its management.

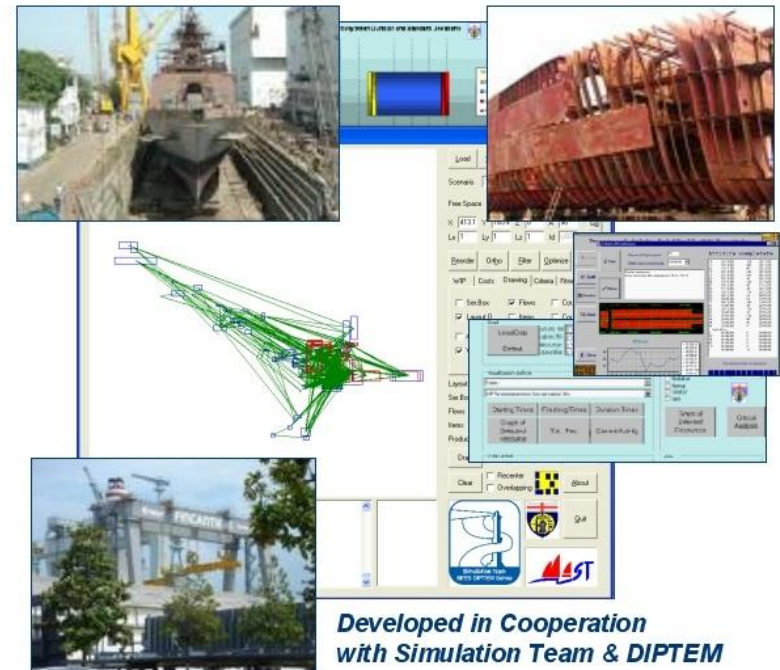

*Developed in Cooperation
with Simulation Team & DIPTM*



LEXIS for Port Terminals



LEXIS (Layout Excellence and Integrated Simulation) represents a solution to Optimize Terminal Layout and Area Assignments by combining a Smart Optimization Framework with an Interactive Dynamic Simulation of the Processes.

LEXIS includes possibility to consider external areas and outsource services



Developed in Cooperation
with Simulation Team & DIPTEM



Email: info@mastsrl.eu

URL: www.mastsrl.eu



Frine

Forecasts Robust Intelligent Evaluator

FRINE is a modular approach for supporting inventory management, purchasing and outsourcing planning in telecommunication production industry.

FRINE includes: Frine Sim a detailed simulator for evaluating different scenarios, Frine ANN an intelligent forecast system based on Artificial Neural Networks and Commercial Data Fusion and a Frine Metrics for on-line performances measuring and controlling.

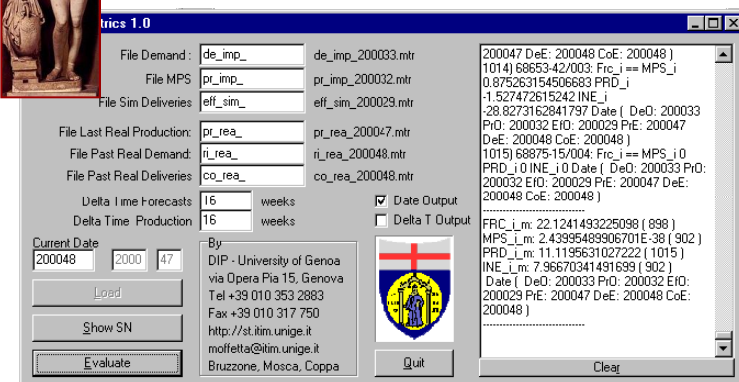
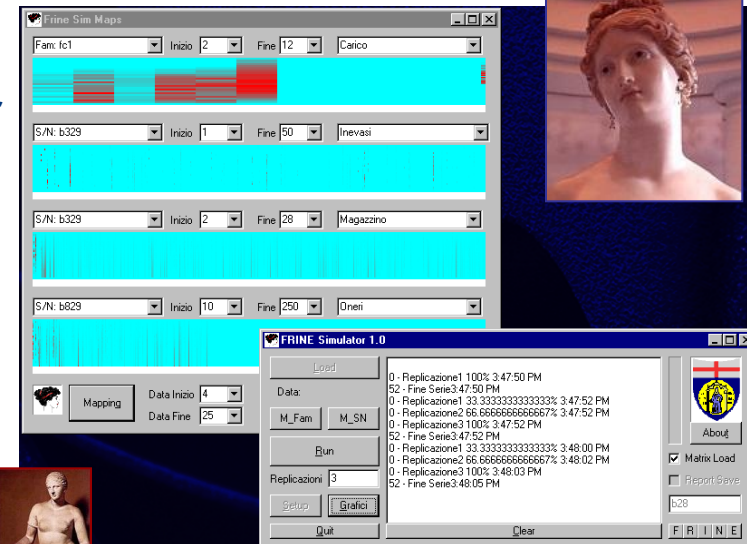



VAED

Virtual Aided Engineering & Design

VAED is a joint cooperation between Genoa University and Ansaldo for the development of Distributed Synthetic Environment for Power Plant Design.

A prototype has been developed and used for supporting design of Burners, Piping, DCS of a Gas Turbine in joint project with Siemens.

A set of demonstrators has been implemented and tested to support Project Management applied to these projects.

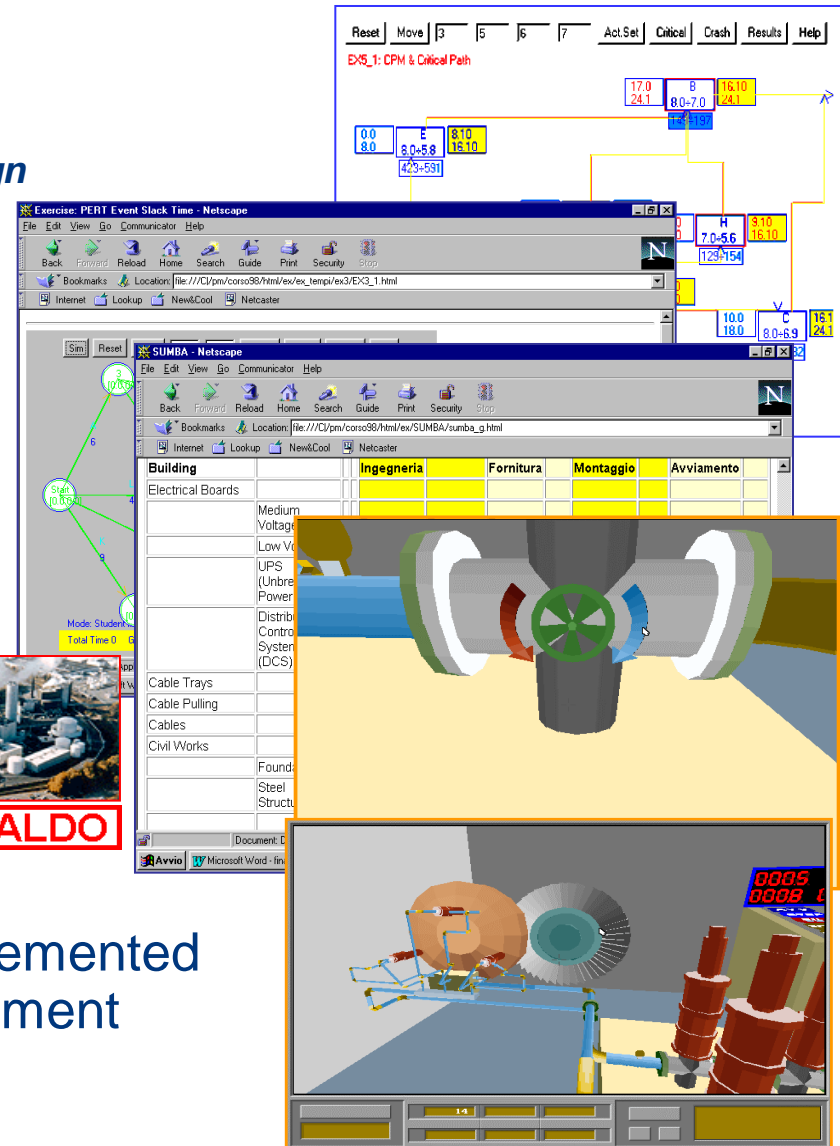



COUGAR

Controller & Organizer for Ultimate Government of Availability and Reliability

COUGAR is the innovative system for the Service and Maintenance of complex systems (i.e. Helicopters). The system is designed to satisfy the requirements connected with the maintenance management of helicopters taking care of both pre-planned and emergency actions.

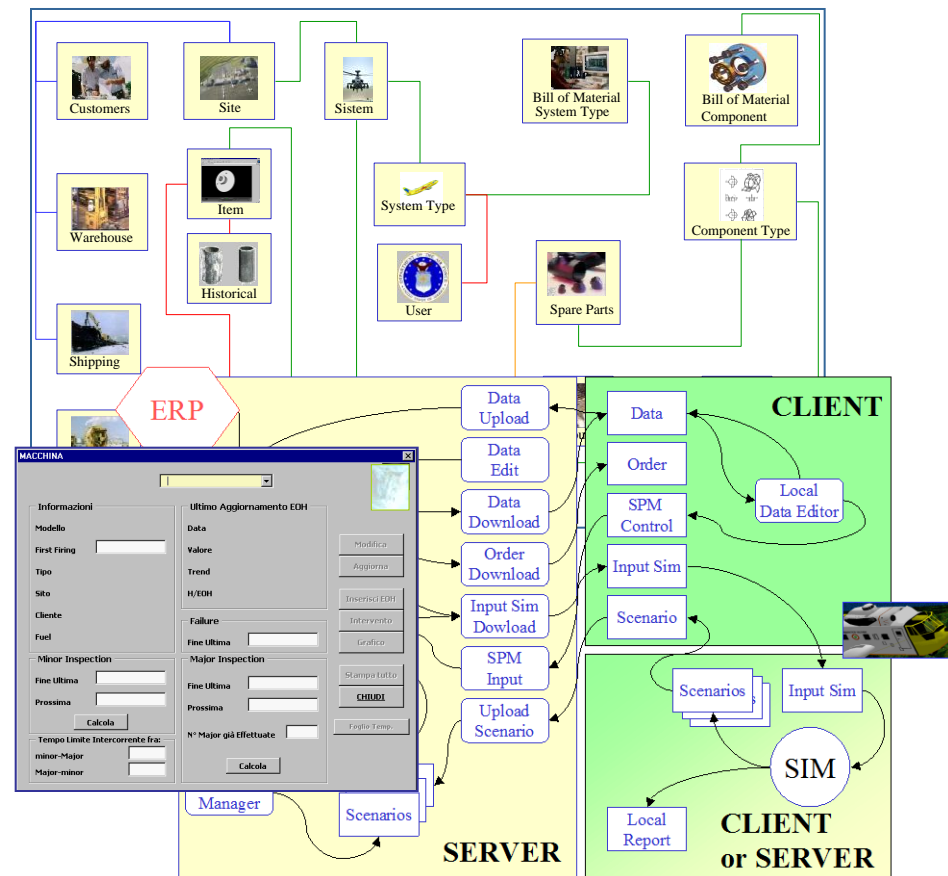



PUMA

Project for Ultimate MAintenance

PUMA is the innovative system for re-organizing Gas Turbine Service in Ansaldo Energia. The system allows to manage resources, spare parts, internal/external warehouses, shipping and scheduling of all the maintenance operation for over 50 power plants distributed world-wide.

The screenshot displays the PUMA DATA SERVICE interface with several windows:

- PUMA DATA SERVICE:** Main dashboard with icons for CLIENTI, STORICO, ORDINI, SITI, ITEM, MAGAZZINI, TIPI, MACCHINA, and SIMULATORE.
- ASSE MACCHINA:** Window for selecting an axle (SELEZIONE ASSE: MIRFA_TG643).
- PUMA Simulator:** Window showing simulation parameters and data.

File Output	Value
Onere Magazzino Ansaldo.....(Lit/Mese)	12087414
Onere Magazzino Sit.....(Lit/Mese)	84607512
Onere Pezzi in Viaggio.....(Lit/Mese)	6881925
Costo Pezzi Installati.....(Lit/Mese)	12310192
Costo Handling.....(Lit/Mese)	51250288
Costo Spedizione.....(Lit/Mese)	37423912
Costo Stock - Out.....(Lit/Mese)	25239000
Numero Blocchi.....(N/Mese)	4
Costo Ripoting.....(Lit/Mese)	0
Giorni Fermo Macchina.....(gg/Mese)	17
Numero Ordini.....	36087
- Stati Operativi Macchina:** Legend for machine states:
 - Ferma (White)
 - Avvio (Red)
 - Marcia (Green)
 - Ferma Minor (Pink)
 - Ferma Major (Purple)
 - Ferma Guasto (Brown)
 - Inizio Minor (Yellow)
 - Inizio Major (Blue)
 - Inizio Riparazione (Cyan)



WOLVES

Warehouse Organization & Logistics Virtual Environment Simulation

WOLVES focuses on Inventory Management & Warehouse Control in an advanced Framework integrating ERP, AI, Forecasting and dynamic planning. WOLVES was successful applied to a wide spectrum of industrial cases: from SME involved in production to large mass transportation companies; the results obtained was usually very successful reducing the inventory even to 50% with service improvements

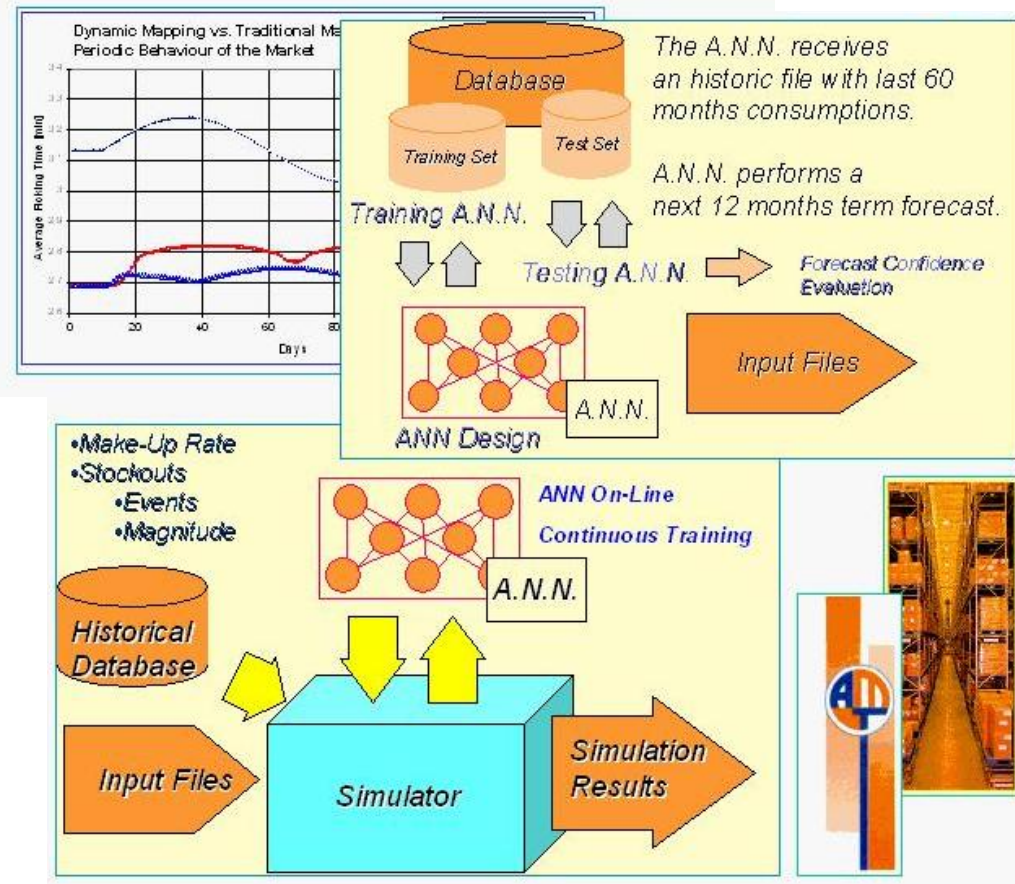



FUSE

Fuzzy Logic Schedule Analyzer

AnsaldoEnergia

FUSE is a package operating on PC and fully integrated in Office Suite for Supporting Planning and Management of Power Plant Service.

FUSE analyzes different scenarios providing quantitative measures of the critical issues including: contractual aspects, technical regulations, resource constraints, user needs, etc. FUSE properly reproduce the different parameters in order to support operative planning

The screenshot displays the FUSE software interface. On the left, there is a 3D model of a large industrial component, possibly a turbine or generator, being lifted by a crane. The main window shows a data table with the following content:

FERRERA E. ENPOWER 1	0.69	0.69	1.00	0.76	1.00	0.76	1.00	0.76	1.00	0.00
FERRERA E. ENPOWER 2	0.68	0.68	1.00	0.80	1.00	0.80	1.00	0.80	1.00	1.00
RAVENNA ENPOWER 1	0.68	0.68	1.00	0.80	1.00	0.80	1.00	0.80	1.00	1.00
FERRERA E. ENPOWER 4	0.69	0.69	1.00	0.80	1.00	0.80	1.00	0.80	1.00	1.00
RAVENNA ENPOWER 3	0.69	0.69	1.00	0.80	1.00	0.80	1.00	0.80	1.00	0.80
FERRERA E. ENPOWER 1	0.71	0.71	1.00	0.80	1.00	0.80	1.00	0.80	1.00	0.80

Below the table, there is a summary window titled "FUSE: Easy Scheduling Evaluator" showing a "Scheduling Quality" of 35/100. The interface also includes buttons for "Visualizza Scenario", "Risultati", "Ejibara", and "Fino".



LEM

Logistics Evaluation Model

LEM Project is a joint venture among Ford, Boston College, LSC & Genoa University for Developing a Web Based Support System for Supply Chain management.

Tests using LEM beta_modules have been carried out successfully on over 70 logistics centers.



LEM MAIN Menu

Cars

SUPPLIERS: Products, Capacity

PRODUCTION: Sites, Lines

Production Supplies

Production Lines Menu

Line ID	Line DAE1	Line DAE2	Line B&S	Line A1	Line A2
Car Type	Luxury	Compact	Luxury	Compact	Compact
Site	PS_01	PS_01	PS_02	PS_03	PS_04
Location	Pittsburgh	Pittsburgh	Clinton	Pocahontas	Florissant
Initial Max Capacity	600,000	400,000	500,000	750,000	750,000
Productivity Increase	-	-	-	-	-
Theoretical Productivity	600,000	400,000	500,000	750,000	750,000
Current Production	400,000	250,000	200,000	650,000	400,000
Productivity	80%	63%	40%	87%	53%
Overall Efficiency	97%	97%	98%	94%	97%
MTBF	19.0	16.0	19.0	31.0	31.0
MTTR	1.4	1.2	1.4	2.2	2.0

Production Supply Chain

Production Site: PS_01 Pittsburgh

Car Model: CA_02 Car Mago

Update	Chassis	Tires
Supplier	SUP_18 Sp	SUP_14 To
Production Frequency	1.0	1.0
Quantity	274	1,370
Warehousing		
Calculate	Distance: 233	2
	Transport No.	12

Cost for Improving Productivity	9.78	8.8	9.78	8.8	8.7
Cost for Enabling new Cars same type	150,000	100,000	160,000	140,000	140,000
Car already Enabled					
CA_01	Yes	Impossible	Yes	Impossible	Impossible
CA_02	Yes	Impossible	Yes	Impossible	Impossible
CA_03	Impossible	Yes	Impossible	Yes	Yes
CA_04	Impossible	Yes	Impossible	Yes	Yes
CA_05	Yes	Impossible	Yes	Impossible	Impossible
CA_06	Impossible	Yes	Impossible	Yes	Impossible
CA_07	Impossible	Impossible	Yes	Impossible	Impossible
CA_08	Impossible	Yes	Impossible	Yes	Impossible





BALI

Bay Advanced Logistics Integrator

BALI is a web solution for planning the access of trucks to docking bays in order to consider planning, use coefficients, workloads, management of new time slots and different kind of goods. By this approach it is possible to obtain significant benefits in term of reduction the waiting time of trucks and optimize the workload

- Truck Driver
- Transportation Company
- Supplier
- Wholesaler
- Manufacturer

BALI

Administrator

Planned

Warehouse

Management

BALI - Windows Internet Explorer
http://localhost:51269/UI/Pages/Traspo

BALI

Prenotazioni

Ciente Location Highway Store Milano Sud Gruppo Baie Tipo Baie Secco Secco

Occupazione Occupazione Sett Prec

August 06, 2009

01 Baie

4:00 5:00 6:00 7:00 8:00 9:00 10:00 11:00

BR

Start time: 8:00

01



Simulation Team

BALI

HOME LOCATION GRUPPI BAIE UTENTI PRENOTAZIONI **PLANNING** CREDENZIALI LOGIN

Gestione Appuntamenti

Location Gruppo Baie Legenda

Milano Sud Prenotazioni Mostra Tutto

Tipo Baie

Occupazione Occupazione Sett Prec Tempo Servizio Medio Appuntamenti Visibili

August 06, 2009

01 Baie, 02 Baie, 03 Baie, 04 Baie, 05 Baie, 06 Baie, 07 Baie, 08 Baie, 09 Baie

01 Baie 02 Baie 03 Baie 04 Baie 05 Baie 06 Baie 07 Baie 08 Baie 09 Baie 10 Baie 11 Baie 12 Baie 13 Baie 14 Baie 15 Baie 16 Baie 17 Baie 18 Baie 19 Baie 20 Baie 21 Baie 22 Baie

4:00 5:00 6:00 7:00 8:00 9:00 10:00 11:00

Logistica Management

Newsletter

euromerici

ST





J20 Experience

E-Learning Concurrent/Cooperative Project Game

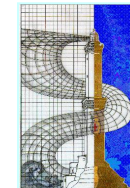

J20 allows to experience in a Web Based Environment a New Product Development by working in Cooperative Teams (Engine, Avionics Cell) representing different Joint Ventures competing for the Project a New Advanced Fighter.

The Exercise has been extensively tested in Distributed Environment for Professional and Academic Courses

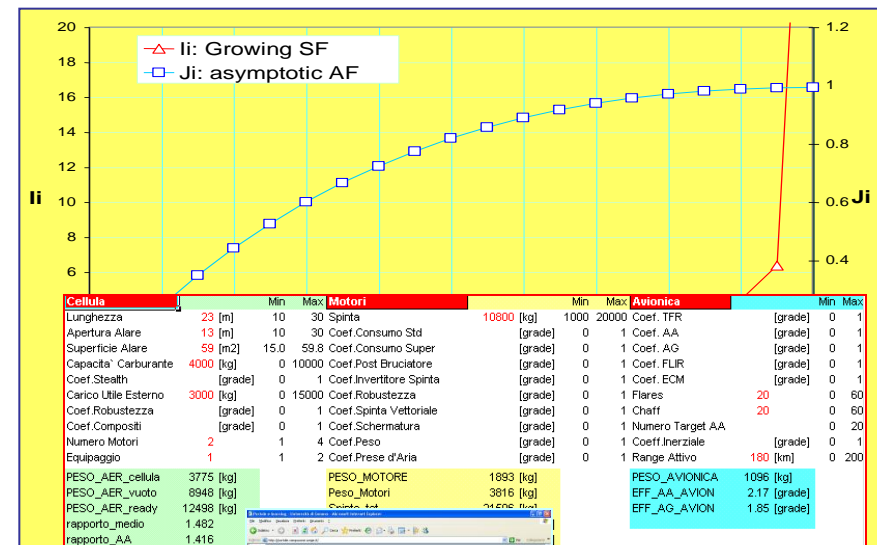



WORM & WASP

*Work Organization for Railways cargo Management
Wide Analysis of rail System and Performances*



WORM is a simulator of freight rail operations for estimating service quality and costs.

WASP is a data mining system and smart performance analyzer directly integrated in railways information system.

WASP & WORM are integrated to operate as DSS for ASA Logistics Div. in Italian Railways

WORM

== UW(0) SOP:2 TOP:1209.5 Ps[0 * 4 * 0]
 == UW(0) SOP:3 TOP:1291.7 Ps[0 * 4 * 0]
 == UW(0) SOP:4 TOP:1291.7 Ps[0 * 4 * 0]
 == UW(0) SOP:5 TOP:1301 Ps[0 * 0 * 0]
 == UW(0) SOP:8 TOP:1451.7 Ps[0 * 21 * 0]
 == UW(0) SOP:9 TOP:2170.9 Ps[0 * 21 * 0]
 == UW(0) SOP:10 TOP:2202.9 Ps[0 * 0 * 0]
 == UW(0) SOP:11 TOP:0 Ps[0 * 13 * 0]

W.A.S.P. Main

Risultati	Risultati	Risultati	Risultati
matricola 0183075610 1) CMVR 0 min 0 km V 2) SPVU 0 min 0 km V matricola 0183120045 1) matricola 0183120148 1) 1) 2) 2) 3) 3)	matricola 0183075610 1) NVVU 5030 min 0 km V matricola 0183120045 1) EMVU 0 min 0 km V matricola 0183120148 1) NVVU 0 min 0 km V 2) NVVU 0 min 0 km V 3) NVVU 0 min 0 km V	matricola 0183075610 1) ATVU 185 min 3 km V matricola 0183120045 1) matricola 0183120148 1) 1) 2) 2) 3) 3) ATVU 465 min 244	matricola 0183075610 1) VAVU 41 min 26 km V 2) matricola 0183120045 1) VAVU 63 min 59 km V matricola 0183120148 1) VAVU 60 min 129 km V 2) VAVU 100 min 125 km V 3) CAVU 110 min 417

SELECT FILE SETTINGS CLEAR
 DOWNLOAD NEW ANALYSIS W.A.S.P. EXIT



SOFRA & ATARDPL

Cleaning & Garbage Collection

The projects SOFRA focuses on Street cleaning in an urban context and use a combination of Genetic Algorithms and Simulation in order to optimize mission planning considering all the constraints; this approach guarantees improvements of 30% in term of quality of the service without additional investments just based on mission reorganization

The ATARDPL is based on SOFRA concept and it is devoted to Garbage Collection Planning (i.e. plastic, glass, paper) in Environmental Town Management and it guaranteed on real cases improvements in term of cost savings (10-20% reduction).

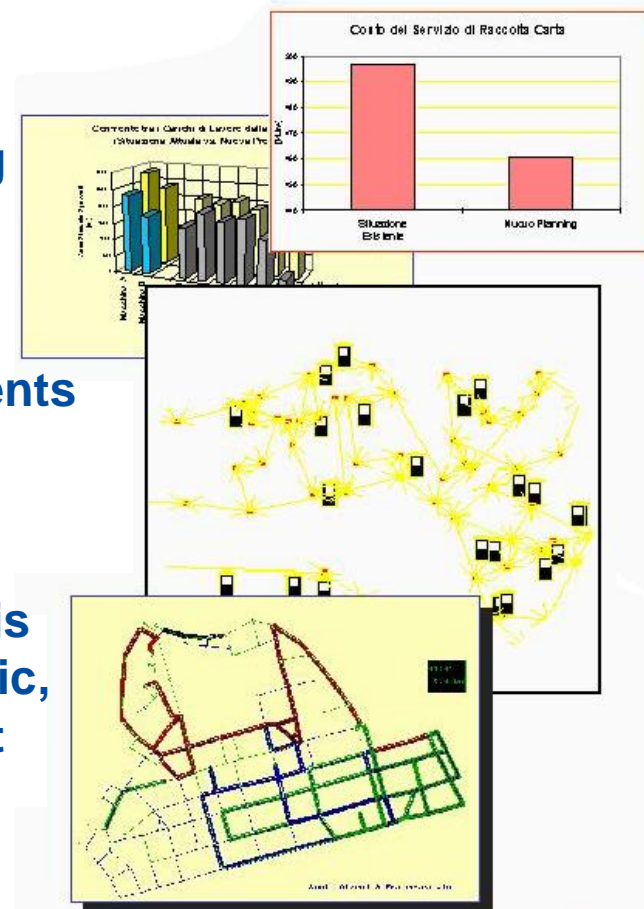



San Paolo 2000

San Paolo Hospital in Savona: Simulation for Architecture

San Paolo 2000 is the integration of simulation with architectural techniques for functional design and analysis of urban areas and buildings.

The system reproduce the Savona Downtown with the restoring project of this building using VRML 2.0 for exploitation of the results in the public community by WWW; it's possible to navigate in the scenario and to watch the interactions of simulated cars and people

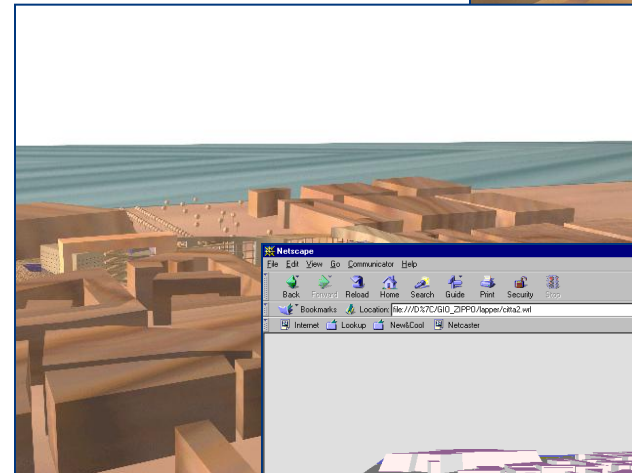
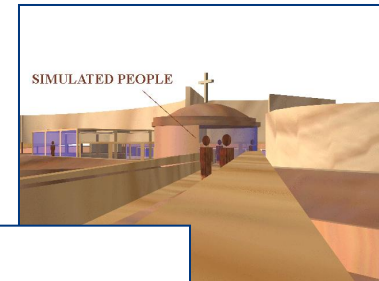



Alippo

Virtual Prototyping for Automotive Production & Design

Alippo Project is the development of a Model for integrating Design and Production Environment in Automotive Component Industry.

The system connects the Product Design provided by CAD systems (i.e. CATIA) with the Production Processes using Simulation.

Alippo simulates the production system considering the changes and valorizes the design changes in terms of Work in Process, Warehouse Saturation, Effective Productivity etc.

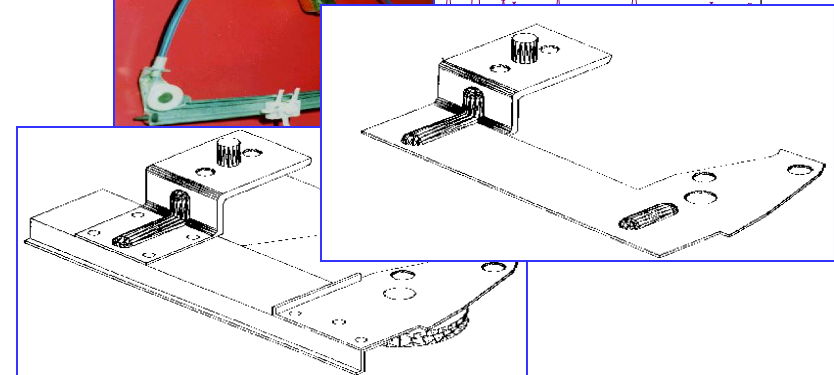
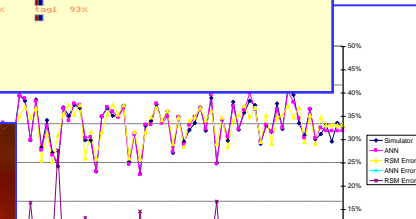
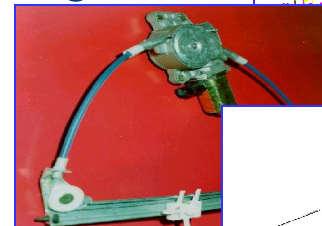
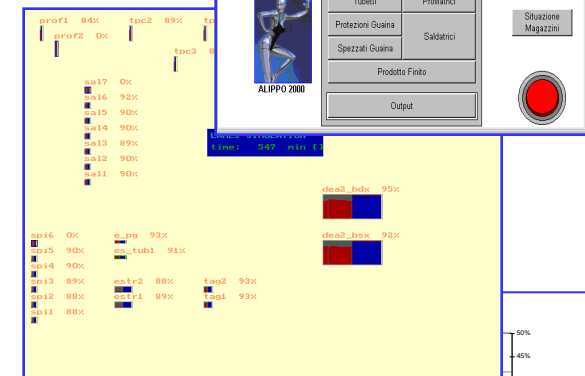
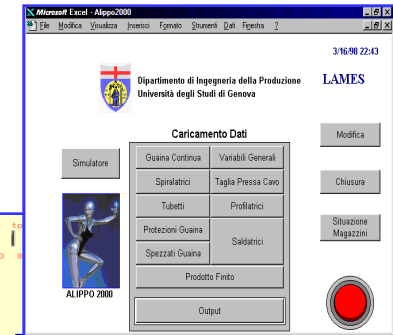



TRAMAS 4.0A

Transportation Management & Simulation for Transportation Managers

TRAMAS 4.0A is a tailored release devoted to organize Business Games for Education of Managers from Small Medium Size Transportation Enterprises. The Project was successfully applied in several courses sponsored by Italian Transportation Department.

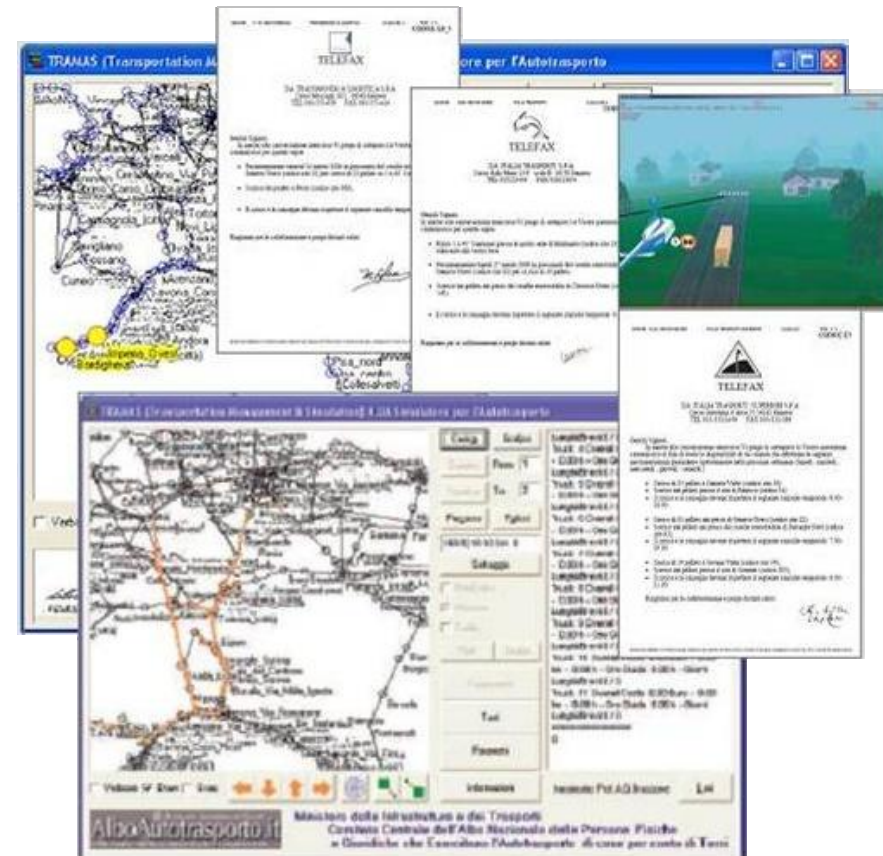

Ministero delle Infrastrutture e dei Trasporti
AlboAutotrasporto.it
 Comitato centrale per l'Albo Nazionale degli autotrasportatori di cose per conto di terzi



TRAMAS

Transportation Management & Simulation

TRAMAS is devoted to analyze complex scenarios involving transportation over a wide geographic area. The TRAMAS Simulator analyzes Costs, Times, Constraints and includes all the major factors such as:

- Traffic
- Weather
- Road Saturation
- Time Constraints
- Infrastructures
- Logistics Processes
- Cooperative Operations
- Shuttle Services
- Multipick and Multidrop

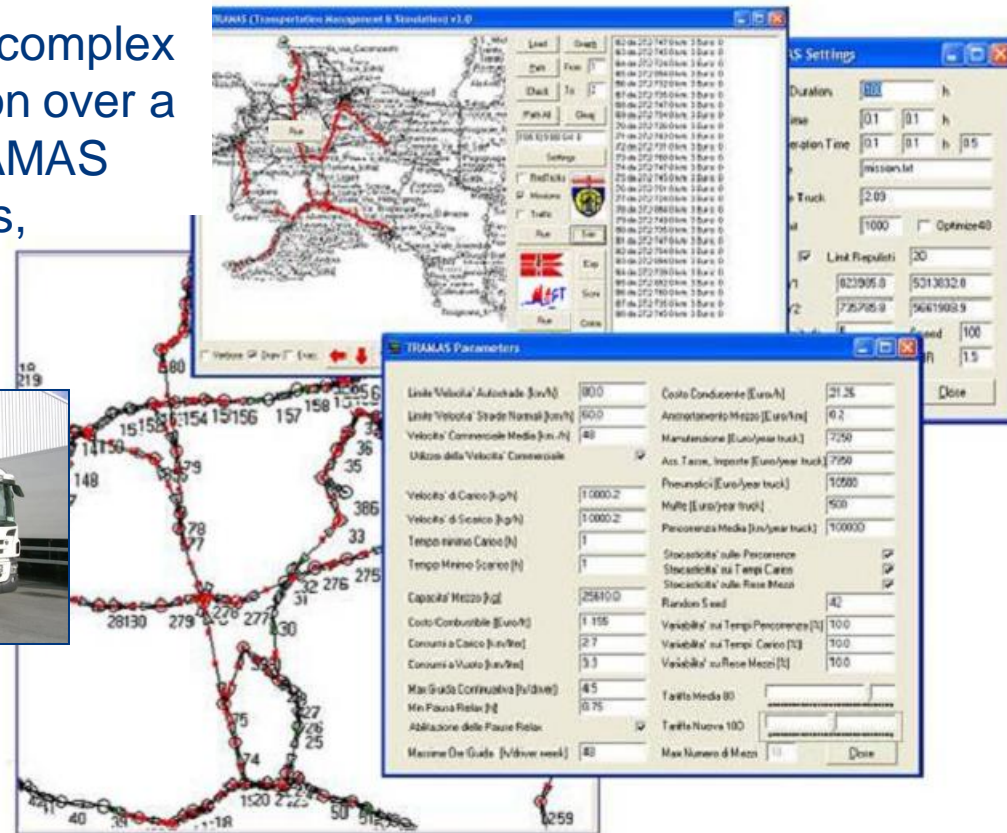



DISPOS

Disponibilità di Impianti di Scasellatura POStale



DISPOS is a suite devoted to certify availability and reliability in complex postal Production Lines characterized by multiple operative configuration.

DISPOS integrates historical data with *a priori* analysis based on simulation.

The systems include references to the international regulations (i.e. CQA UNI 9910, FEM 9.221, NASA TM4628A, DR01-3 DR01-27 NASA LeRC r4, MIL-STD-1388-2B, MIL-STD-49506)

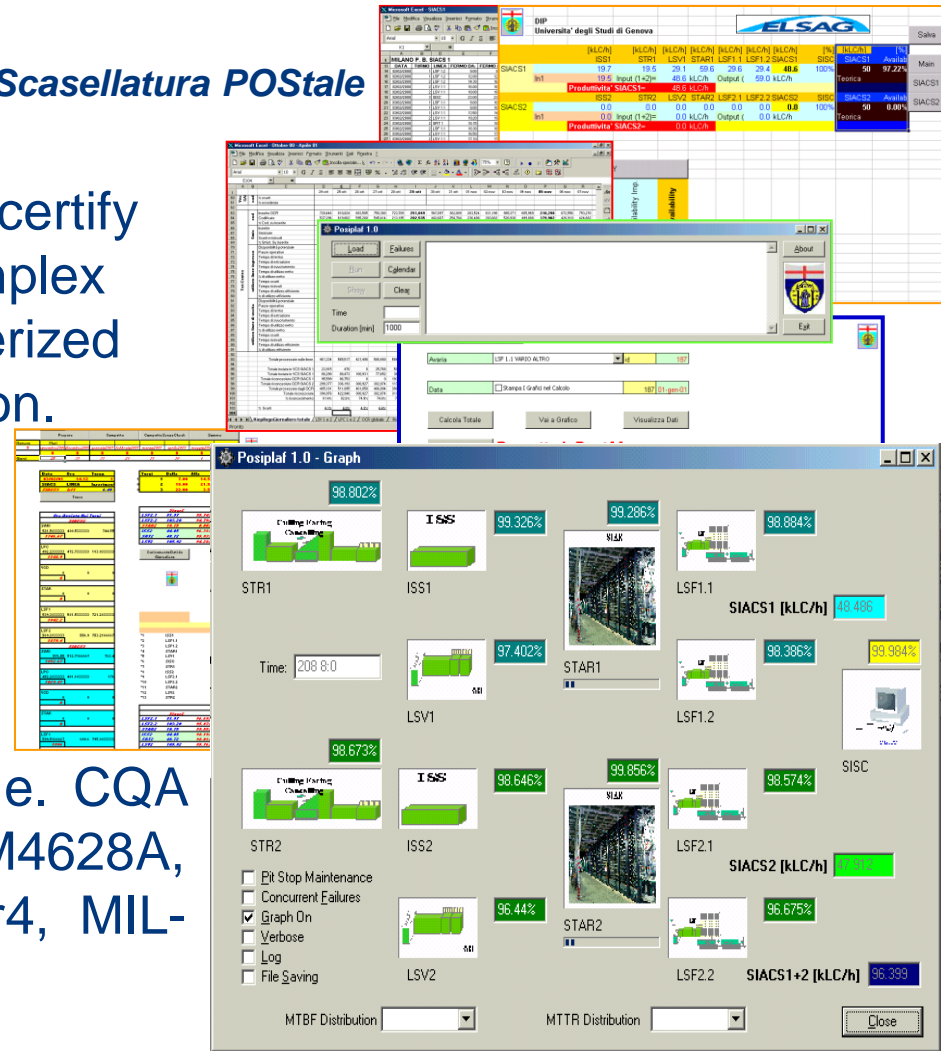



MACACO

Modelling Air Craft Analysis for Construction process and Organization

MACACO is a solution for improving production of executive planes in Aerospace Industry. The project involved data collection and analysis, modeling and simulation, experimental analysis as well as development of Intelligent systems based on AI for identify source of risks for plane due deadline.

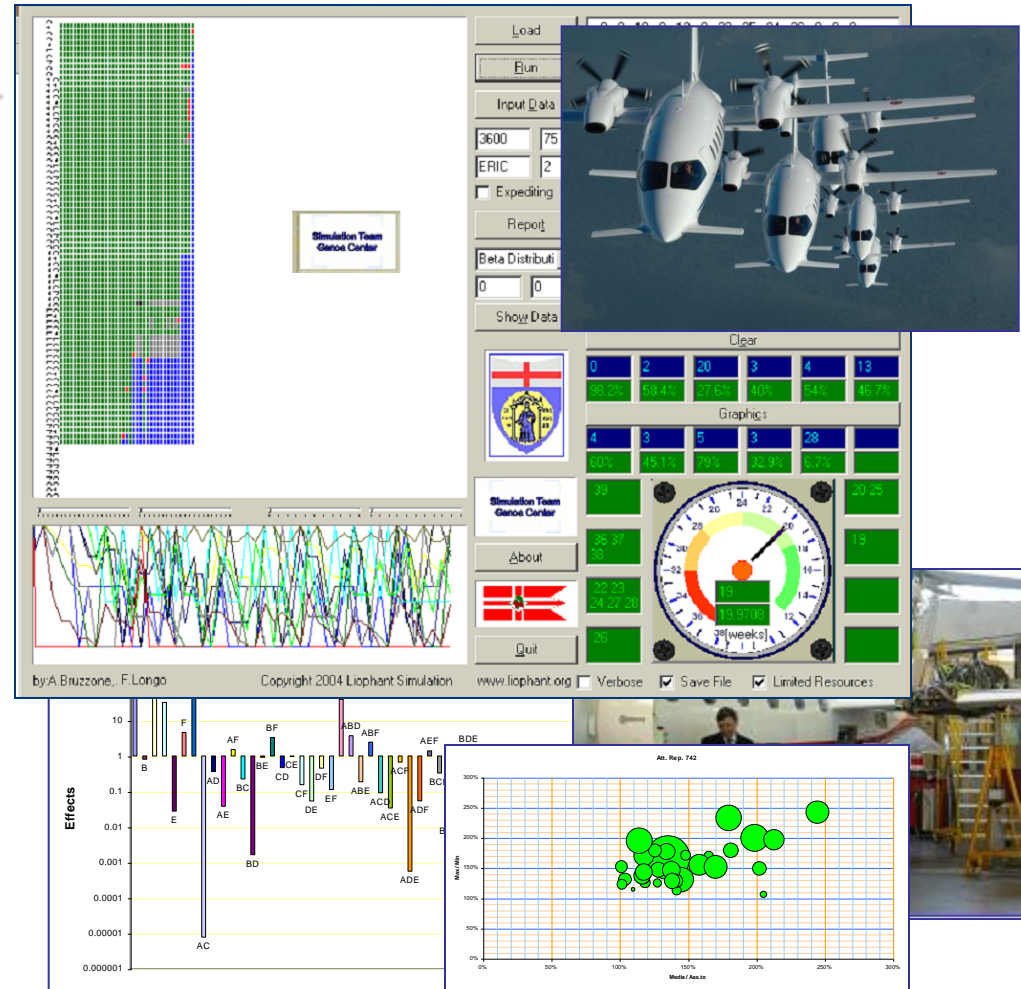



WILD

Web Integrated Logistics Designer

The WILD project involves the development of a Federation composed by Simulators, Scheduling Systems and ERP.

WILD Federation reproduces the supply chain and supports on-line distributed management and control among customers, main contractors, suppliers

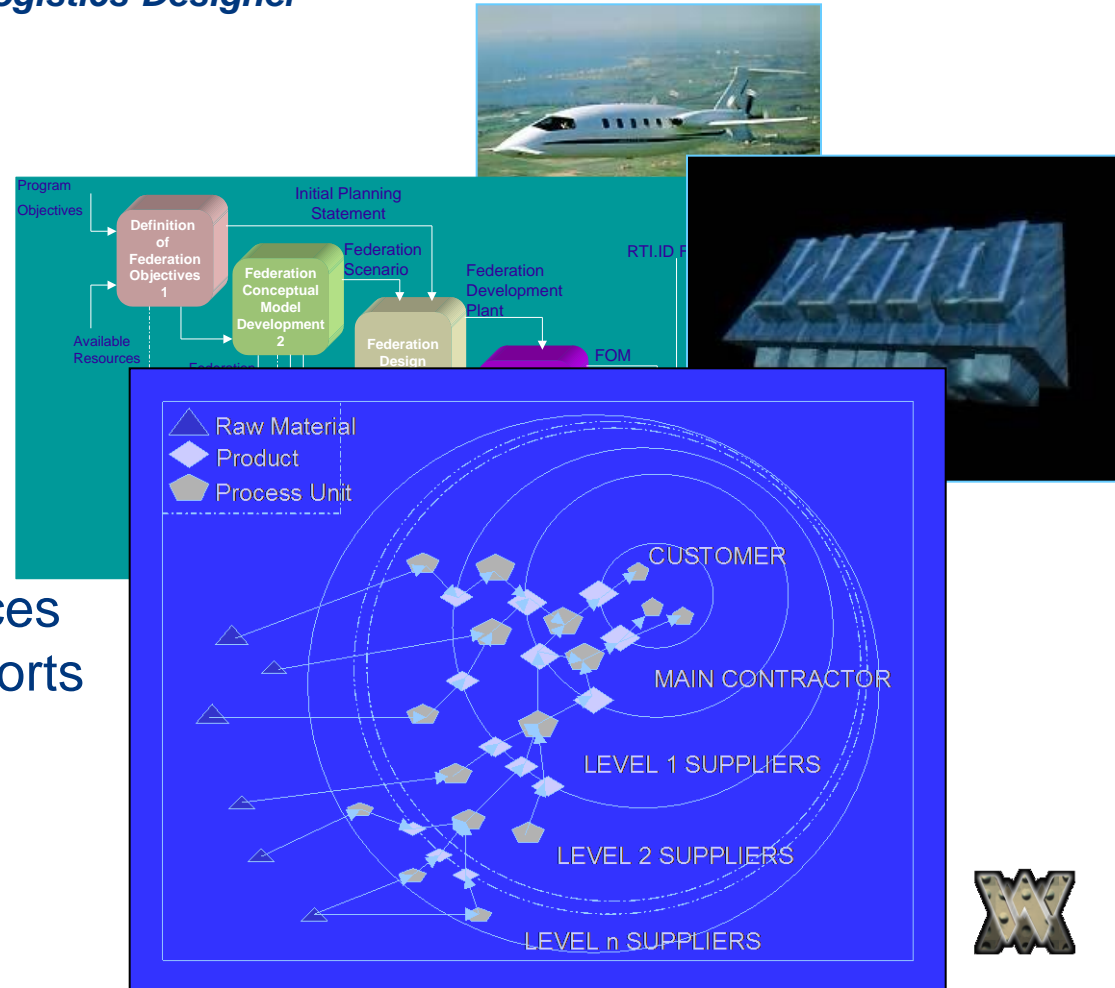



MARLON

MARitime LOGistic Network

MARLON is a model that allows the evaluation of costs related to different marine logistics scenarios. MARLON has innovative features like interoperability, Interactivity and Integration with GIS so companies have demonstrated interest about these; MARLON is a critical support for organizing distributed Meetings concerning tactical and strategic decisions on logistics and production (investments and budget) as well as Videoconferences to evaluate critical operations and scheduling decisions. MARLON is an integrated solution combining Simulation and Optimization, so MARLON is a DSS that improves planning and management of resources for liquid bulk transportation reducing the total cost for transportation and related risks. MARLON also allows to put in contact logistics with production and make their integration in the company's context easier. MARLON simulator has been tested and validated giving outputs compatibles with other models and with real industrial case.



Marlon Parameters

- Ports
- Flows
- Paths
- Ships
- Save on File
- Verbose Reports
- Dynamic Update
- Random Seeds: -1
- Duration: 1
- Regular Fuel Cost [%]: 1
- Port Fuel Cost [%]: 1
- Increasing Tanks Capacity [%]: 1
- Increasing Piping Flow Capacity [%]: 1
- Production Increase [%]: 1

Marlon - Maritime Logistics Networks

34	Bitessa2	36.7167	20.8500
35	Bitessa3	35.9500	23.1167
36	Bitessa4	37.6667	24.1833
37	Bitessa5	38.2167	24.8333
38	Bitessa6	39.2667	24.0167
39	Bitessa7	40.4333	22.7500
40	path4sottosicilia	36.2500	16.8333
41	path4ardegnacorsicaest	41.2833	9.7666
42	manica	50.8833	1.6167
43	nordhamburg	54.7167	6.4833
44	imboccaregibilterraest	36.3500	-1.4000
45	daravennaamarghera	44.9333	12.6833

Flows

1	flow1	4 Priolo_C4 Ravenna_C4	2795.3462
2	flow2	4 Porto_Marghera_C4 Ravenna_C4	1867.7693
3	flow3	5 Porto_Marghera_Etilene Omisali_Etilene	1487.9423
4	flow4	5 Priolo_Etilene Vada_Etilene	1406.2693
5	flow5	3 Brindisi_Butadiene Ravenna_Butadiene	1335.8269
6	flow6	1 Priolo_Propilene Brindisi_Propilene	1159.8654
7	flow7	1 Porto_Torres_Propilene Brindisi_Propilene	1010.2692

Ports Sites Ships Demand Flows Missions Reorganize Quit

Copyright (c) 2004-2010 Simulation Team MISS DIPTM University of Genoa GIS On Dynamic GIS



LOGOS

Logistics Optimisation System



EniChem

The project integrates simulation, planning scheduling and optimization methods based on Artificial Intelligence Technique

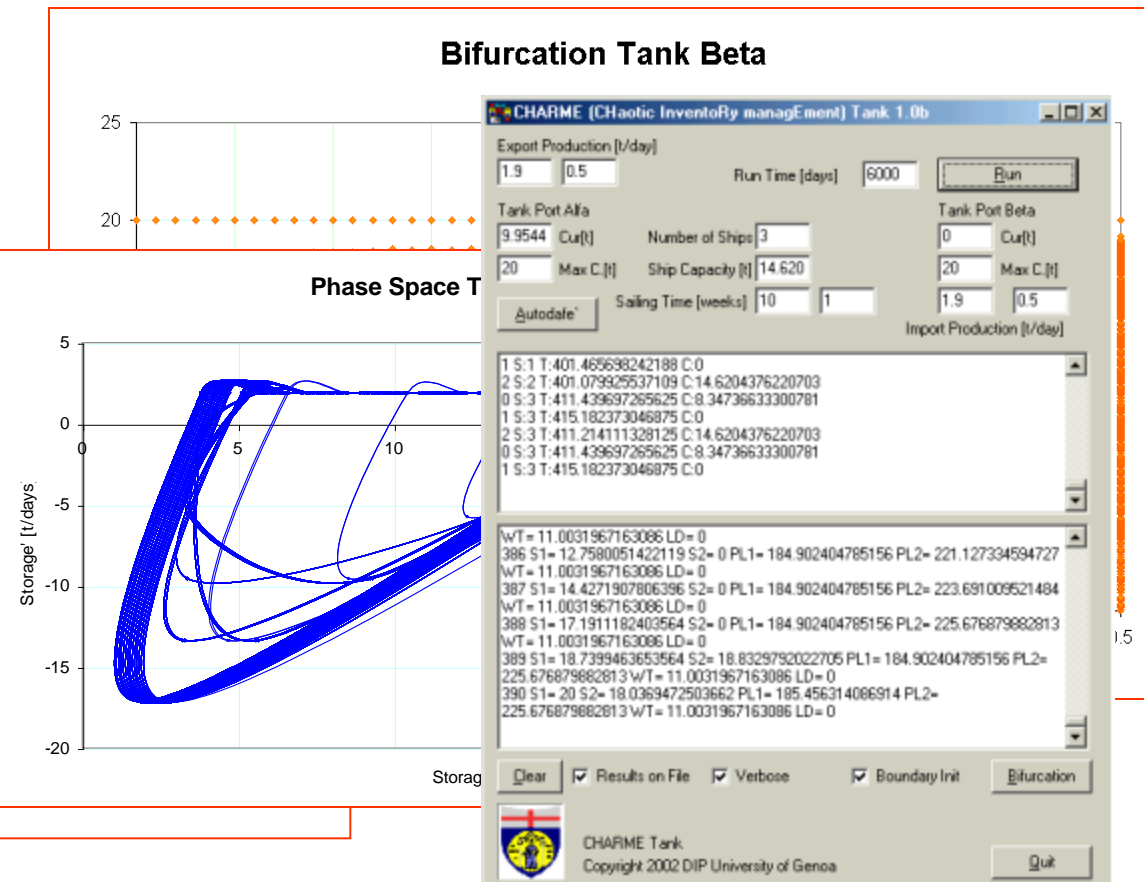
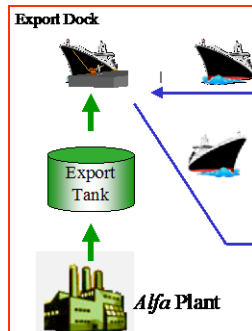



CHARME

CHAotic inventoRY ManagEment

CHARME is a set of modules developed by DIPTTEM/Liophant as dynamic reference for VV&A (Verification, Validation and Accreditation) of LOGOS Decision Support System for Fleet Management (Planning, Scheduling & Simulation) in large chemical industries. CHARME uses chaos theory approach in application to real stochastic logistics networks.



EniChem

Export Production [t/day] 4 1 Run Time (days) 60 Run

Tank Port Alfa Loading Speed [t/day] 24 Tank Port Beta 32.797 Cur[t]

30.188; Cur[t] Number of Ships 6 40 Max C.[t]

40 Max C.[t] Ship Capacity [t] 14 4 1

Autofade Sailing Time (days) 10 Import Production [t/day]

```

0 S:1 T:60.5737838745117 C:0
1 S:1 T:66.513916015625 C:0
2 S:1 T:67.8479614257813 C:0
3 S:3 T:60.0703659057617 C:14
4 S:3 T:60.7590446472168 C:14
5 S:1 T:63.1290740966797 C:0
0 S:1 T:60.5737838745117 C:0
1 S:1 T:66.513916015625 C:0
59.9416847229004 S1= 30.1887321472168 S2= 32.7971496582031 PL1=
7.54530334472656 PL2= 15.9622440338135 W/T= 0.109076499938965 LD=
1.60737609863281
59.942684173584 S1= 30.1887321472168 S2= 32.7971496582031 PL1=
7.54530334472656 PL2= 15.9622440338135 W/T= 0.109076499938965 LD=
1.60737609863281
59.942684173584 S1= 30.1887321472168 S2= 32.7971496582031 PL1=
7.54530334472656 PL2= 15.9622440338135 W/T= 0.109076499938965 LD=
1.60737609863281

```

Ports

- 1 Genova: T:1 X:0 Y:0
- 2 Marsiglia: T:1 X:200 Y:0
- 3 Barcellona: T:1 X:400 Y:100
- 4 Pireo: T:1 X:1000 Y:800
- 5 Porto Saed: T:1 X:1500 Y:1500
- 6 Gibraltar: T:1 X:700 Y:800

Flows

F14 GLPW:900- from:1 to:4 == 2 Done
 F35 GLPW:900- from:3 to:5 == 3 Done
 F24 GLPW:500- from:2 to:4 == 5 Done
 F42 GLPW:500- from:4 to:2 == 3 Done
 F15 GLPW:900- from:1 to:5 == 4 Done
 F61 GLPW:500- from:6 to:1 == 5 Done

Resequencing

3 Barcellona: FT:500 L:2360
 5 Porto Saed: FT:0 L:560
 4 Pireo: FT:500 L:1442
 2 Marsiglia: FT:0 L:223
 Total Cost: 229876

Tank Behaviour

Time (days)

Level

Sequence

Show Clear

Initialize Quit

Liophant Simulation

Copyright (c) 2002 DIP Unige <http://st.rm.unige.it> moffetta@rm.unige.it Extra Empty Cost

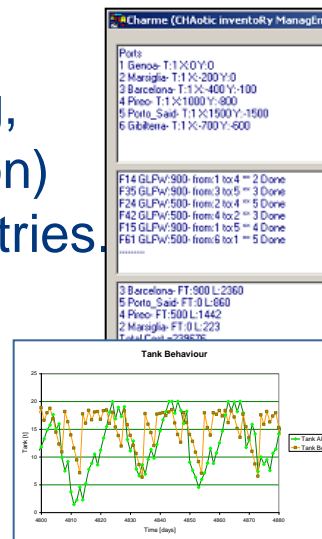



MASC & DICO-SAP

Modeling & Analysis for Satisfaction of Customers
 DIPTTEM-COOP SAP

MASC is a system for Statistical Analysis, Modeling & Simulation applied to big-distribution chains.

The Project is carried out in cooperation with the major Italian company in this area

The final target is to improve the customer satisfaction acting on policies, operating procedures, resources & equipment; the system is fully integrated with company ERP (SAP R/3) and benefits of similar experiences carried out other companies (i.e. Genoa Mass Transportation Company).

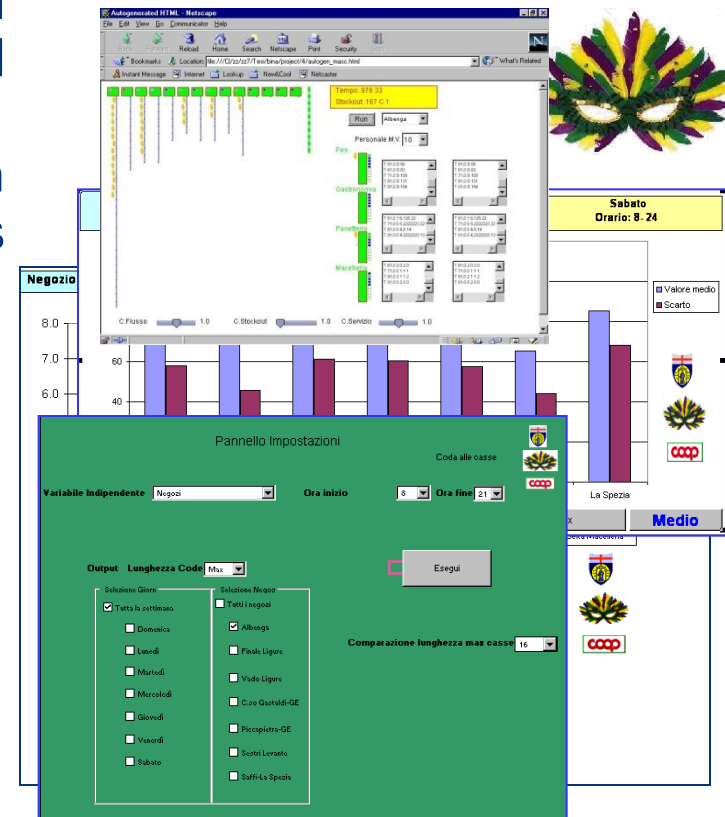



EFESTO

Elaborazione Flussi Economato Sistemi, Tecniche & Organizzazione



The EFESTO project is focusing on the creation of models for Business Process Re-Engineering integrating simulation techniques.

The system allows to integrate Office Suite, with simulation and to distributed the results directly in Intranet managing hierarchical process structure.

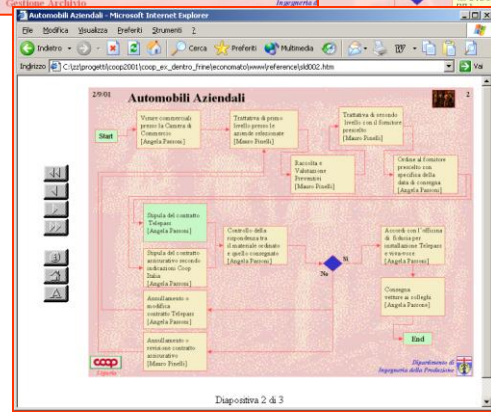
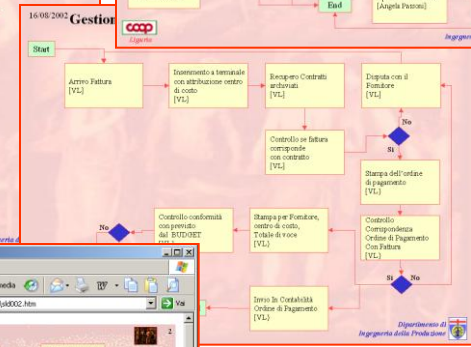
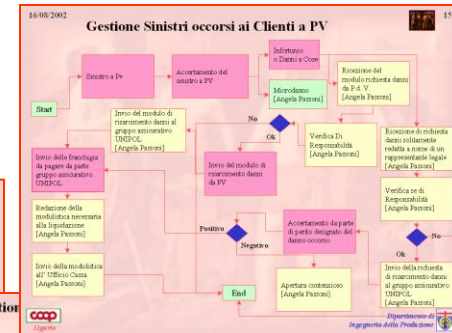



EPEO

Enhancement Process Efficiency & Organization

The EPEO project is devoted to analyze existing structures and to support process re-engineering and reorganization in Business Division of Big Companies geographically distributed. EPEO applies the state of art in Modelling and Simulation and other techniques for Process Identification, Mapping and Quantitative Analysis

	OBS	Model	Delta
CGAL	508.00 h/week	223.9995 h/week	284.00 h/week
RIORD	486.00 h/week	352.96226 h/week	133.04 h/week
SegComm_Lig	304.00 h/week	189.8 h/week	114.20
SegComm_Lom	190.00 h/week	162.75 h/week	27.25
SegComm_Pie	361.00 h/week	238 h/week	123.00

Department	Unit	Scenario
CGAL	CGAL3	Regime

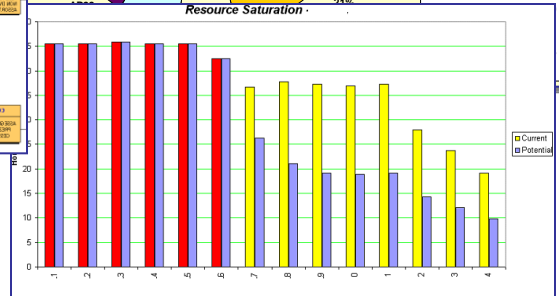
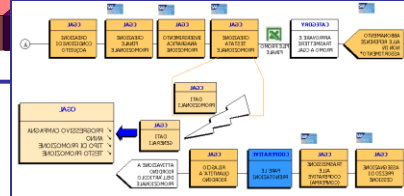
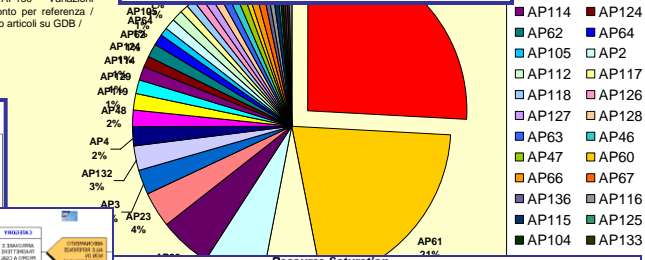
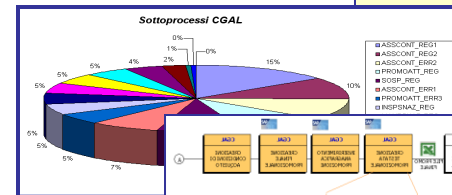
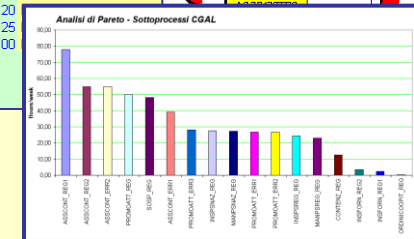
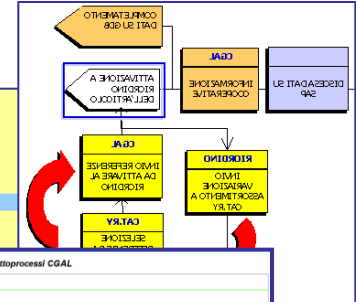



AVICUNICOLA

Project for Logistic Platform devoted to White Meat Fresh Products



The project is devoted to the architecture definition, system development and testing for a new logistics platform integrated in a large supermarket supply chain. The system was implemented in SAP R/3 Retail 4.6™



The screenshot displays the SAP R/3 interface for 'Distribuzione merci: monitor' and 'Elaborare lista pianificazione MRP deperibili'. It includes various data tables and navigation menus.

Articolo	Quantità	Unità	Definizione	Nome 1
178991820	8	COL	086 POL BUSTO COOP GRILL KG 01,000	FILEN SIMAR SRL
178991820	18	COL EUR3	186 POL BUSTO COOP GRILL KG 01,000	GESCO CONS.COOPERATI
178991818	8	COL	086 POL PART COOP SPETT KG 01,000	FILEN SIMAR SRL
178991818	10	COL EUR3	186 POL PART COOP SPETT KG 01,000	FILEN SIMAR SRL
178991818	312380	COL	086 POL PART COOP SPETT KG 01,000	GESCO CONS.COOPERATI
178991830	8	COL	086 POLLO BUSTO COOP CF KG 01,000	FILEN SIMAR SRL
178991830	18	COL EUR3	186 POLLO BUSTO COOP CF KG 01,000	FILEN SIMAR SRL
178991830	69020	COL	186 POLLO BUSTO COOP CF KG 01,000	POLLO DEL CAMPO DUE
178991830	2	COL EUR3	186 POLLO BUSTO COOP CF KG 01,000	GESCO CONS.COOPERATI
178991828	8	COL	086 POLLO PET COOP FETT KG 01,000	FILEN SIMAR SRL
178991828	25340	COL EUR3	186 POLLO PET COOP FETT KG 01,000	FILEN SIMAR SRL
178991828	312380	COL EUR3	186 POLLO PET COOP FETT KG 01,000	GESCO CONS.COOPERATI
178991830	8	COL	086 POLLO PETTO COOP X1 KG 01,000	FILEN SIMAR SRL



NOL

New Opportunities for Logistics

The project is focusing in logistics solution consulting and analysis for CCNO, a Consortium providing Logistics, Administration and IT services to Retail Networks in North Italy.



Consorzio Nord-Ovest

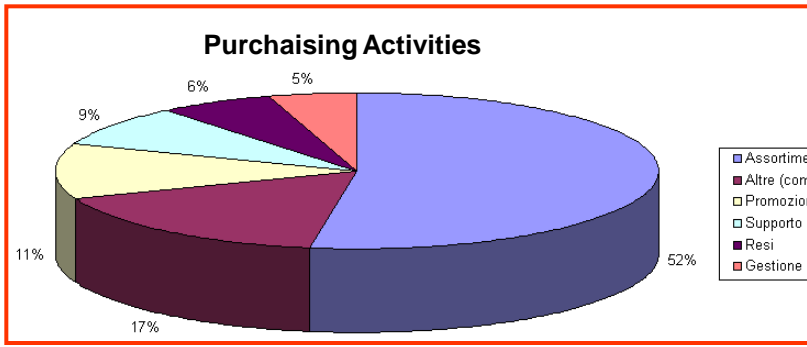
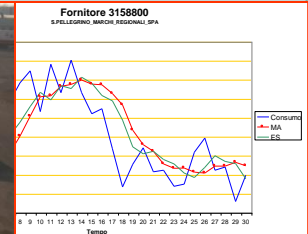
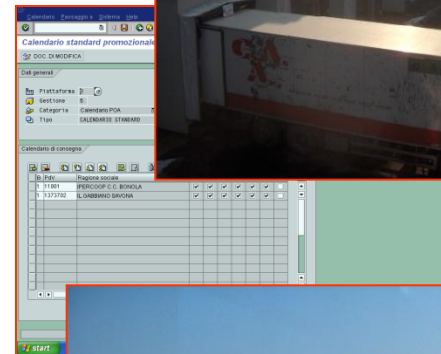
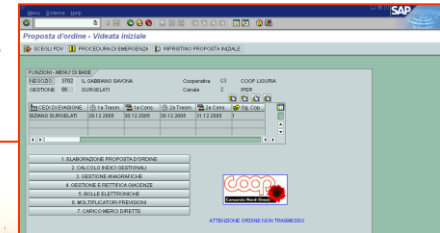



CAPE

Carni & Pesci

The project is focusing in redesign logistics solutions for distribution of fresh food with special attention to Meat and Fish. The project focused on logistics with special attention to platform, infrastructures, processes and distribution policies and procedures.





POA NG

Proposta d'Ordine Automatico New Generation

POA NG is a project for developing a new system for inventory management of shopping centers in large retail chains.

RIO NG optimize the different inventory management models by using stochastic simulation approach and it is currently operative directly implemented in SAP R/3 by major Italian Retailers.

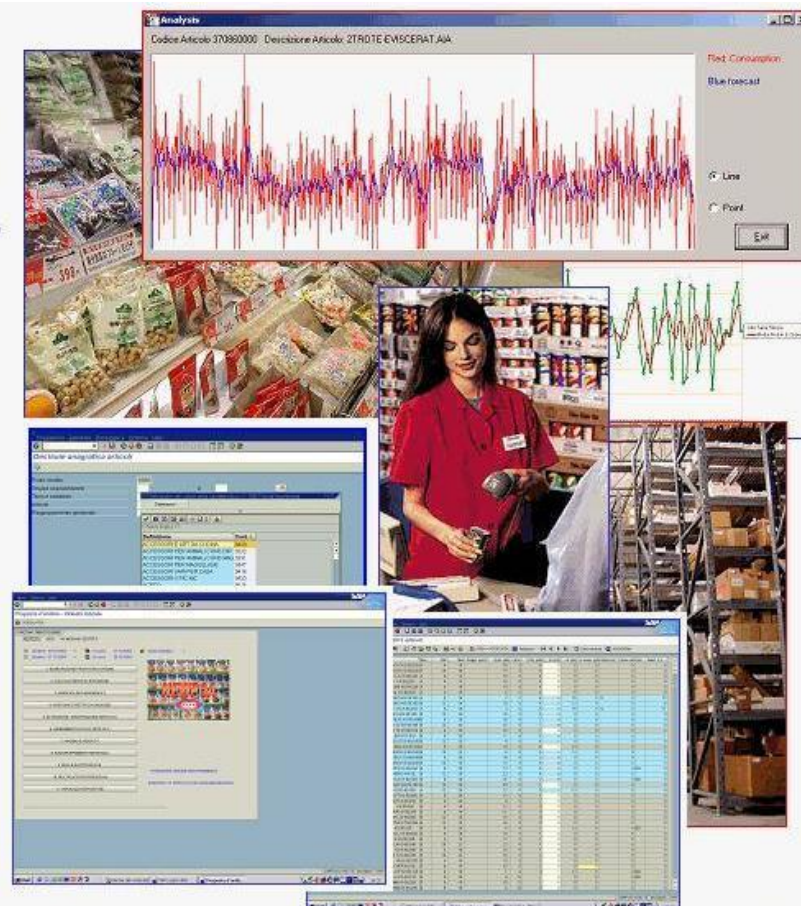



RIO

Renovating Intelligent Operations

RIO is an innovative solution developed in Web Framework for Operation Control in Wide Supermarket Networks. RIO allows both to control store and department performances (sales, customers, goods, productivity, workload) as well as to predict their behavior for improving the performances





6EFFE

Flessibilità a Favore dei Figli e delle Famiglia, Formazione e Fidelizzazione

6EFFE project is a strategic project sponsored by COOP Liguria and National Departments for designing and experimenting new flexible work solution in supermarkets. DIPTTEM was in charge of model development and general architecture design.

MASC NG v2.34b

Entity Process PdV: 62, Dpt: 3, Date: 10012005, Ref: 10012005

Test Time: 36, 42, 80, 425

Day: 6 Hour: 20:45 People: 4
Day: 6 Hour: 21:0 People: 4
Day: 6 Hour: 21:15 People: 4
Day: 6 Hour: 21:30 People: 2.5
Day: 6 Hour: 21:45 People: 1
Day: 6 Hour: 22:0 People: 0.5
Day: 6 Hour: 22:15 People: 0
Day: 6 Hour: 22:30 People: 0
Day: 6 Hour: 22:45 People: 0
Day: 6 Hour: 23:0 People: 0

OGGI: 28/09/2004

Data	Valore	ORARIO DI LAVORO					
		LUNEDI			MARTEDI		
		Mattino	Pomeriggio	Tot	Mattino	Pomeriggio	Tot
31/01/2002	16.21380			0.00			0.00
30/01/2002	75.71480			0.00			0.00
29/01/2002	28.53735			0.00			0.00
28/01/2002	72.20318			0.00			0.00
27/01/2002	51.28307			0.00			0.00
26/01/2002	0.196533			0.00			0.00
25/01/2002	51.36738			0.00			0.00
24/01/2002	28.01448			0.00			0.00
23/01/2002	97.92352			0.00			0.00
22/01/2002	18.61081			0.00			0.00
21/01/2002	19.98752			0.00			0.00
20/01/2002	35.15923			0.00			0.00
19/01/2002	35.90408			0.00			0.00
18/01/2002	76.80631			0.00			0.00
17/01/2002	70.73166			0.00			0.00
16/01/2002	79.77289			0.00			0.00
15/01/2002	62.57597			0.00			0.00
14/01/2002	38.19788			0.00			0.00
13/01/2002	12.18990			0.00			0.00
12/01/2002	49.57652			0.00			0.00
11/01/2002	3.424136			0.00			0.00

Media Mobile: 15
pendenza: 30
arte T1 (c1): 1
arte T2 (c2): 1
Prima: 7
Dopo: 8
line M Mob Pes: 3
orni Settimana: 1.9;2.8;0.75;1.6;0.5;1.4;5
1 (v1): 1.0
2 (v2): 1.0
3 (v3): 2.0

Dati di Origine Grafico Tipico

Generi Vari

	0	0,25	0,5	0,75	1	1,25	1,5	1,75	2	2,25	2,5	2,75	3	3,25	3,5	3,75	4
Lunedì	1	1	1	1	1	1	1	1	1	1	1	1	1	1	1	1	1
Martedì	2	2	2	2	2	2	2	2	2	2	2	2	2	2	2	2	2
Mercoledì	3	3	3	3	3	3	3	3	3	3	3	3	3	3	3	3	3
Giovedì	4	4	4	4	4	4	4	4	4	4	4	4	4	4	4	4	4
Venerdì	5	5	5	5	5	5	5	5	5	5	5	5	5	5	5	5	5
Sabato	6	6	6	6	6	6	6	6	6	6	6	6	6	6	6	6	6
Domenica	7	7	7	7	7	7	7	7	7	7	7	7	7	7	7	7	7

SALUMI E LATTICINI

	0	0,25	0,5	0,75	1	1,25	1,5	1,75	2	2,25	2,5	2,75	3	3,25	3,5	3,75	4
Lunedì	0	0	0	0	0	0	0	0	0	0	0	0	0	0	0	0	0
Martedì	0	0	0	0	0	0	0	0	0	0	0	0	0	0	0	0	0





SPIRALS

Space Interoperable Refilling and Advanced Logistics Simulator

Location: **MOON**

- Latitude: 26 08' 9.94"N
- Longitude: 3 34'40.34"E
- Elevation: -1828.8 m

Simulation Team



SPIRALS Project was developed by students of Genoa and Bordeaux Universities, in Internship in MAST and members of Liophant for Smackdown: this initiative is led by NASA, sponsored by several companies and devoted to advance HLA culture by creating a distributed HLA Federation of a Moon Base. SPIRALS federate is in charge of the inventory management, the operations & logistics in the Moon Base.

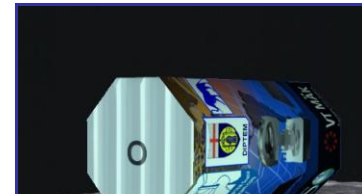



IPHITOS

Interoperable Simulation of a Protection solution based on light Interceptor Tackler operating in Outer Space

Location: MOON

- Latitude: 26 08' 9.94"N
- Longitude: 3 34'40.34"E
- Elevation: -1828.8 m

Simulation Team



MBDA
MISSILE SYSTEMS

TELESPAZIO
A Finmeccanica / Alitalia Company



IPHITOS Project is developed by a team of students from different Universities (Genoa, La Sapienza Rome, Pisa), members of Liophant and students in internship in MBDA and support from Telespazio. This project is devoted to create a federate for Smackdown the initiative, led by NASA & sponsored by several companies, devoted to diffuse and advance the HLA culture by creating a distributed HLA Federation of a Moon Base.

IPHITOS federate is in charge of simulating small asteroids as threats for the Moon Base as well as a Safeguard Solution based on Interceptors, Sensors and Launchers

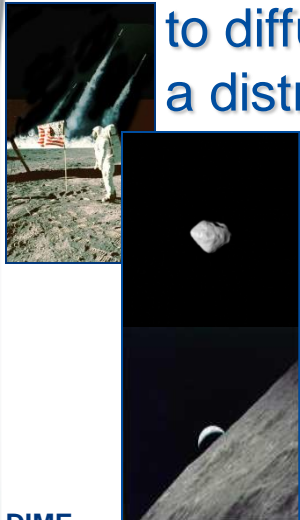
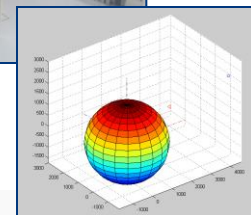
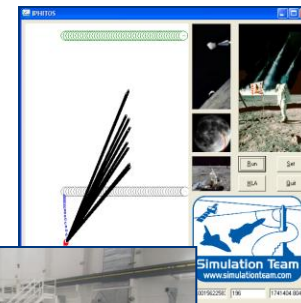

AEGIS
TECHNOLOGIES

SIS

FORWARDSIM
simulations & technologies

NASA

VT MÄK
A company of VT Systems

PITCH



IPHITOS Space Guard

Interoperable Simulation of a Protection solution based on light Interceptor Tackler operating in Outer Space



IPHITOS Space Guard Project is developed by a team of young researchers from Genoa University in Internship in different organizations as new solution for Space Protection against asteroid of IPHITOS. This project is devoted to create a federate for Smackdown 2013 the initiative, led by NASA & sponsored by several

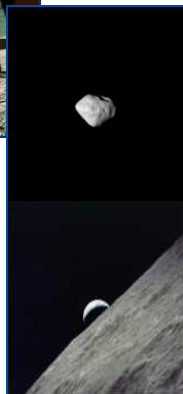
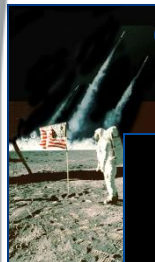

companies, devoted to diffuse HLA Evolved culture by creating a distributed HLA Federation of a Moon Base. IPHITOS federate simulates debris & small asteroids as threats for the Moon Base as well as a Safeguard Solution based on Interceptors, Sensors and Launchers





BACCUS

Behavioral Advanced Characters & Complex Systems Unified Simulator



The BACCUS simulator is intended to be used to study the Obesity Epidemics considering both physiological and social aspects; the model reproduces the population dynamics, estimating correlation among different factors:

- BMI
- Infarct
- Cancer
- Sport Profile
- Atrial Fibrillation
- Hyperlipidemia
- Stroke
- Diabetes
- Alcohol Profile
- Hypertension

BACCUS simulates social networks such as Family and Friends to assess the population evolution and the mutual interaction with diffusion of pathologies



Beth Israel Deaconess
Medical Center

A TEACHING HOSPITAL OF HARVARD MEDICAL SCHOOL

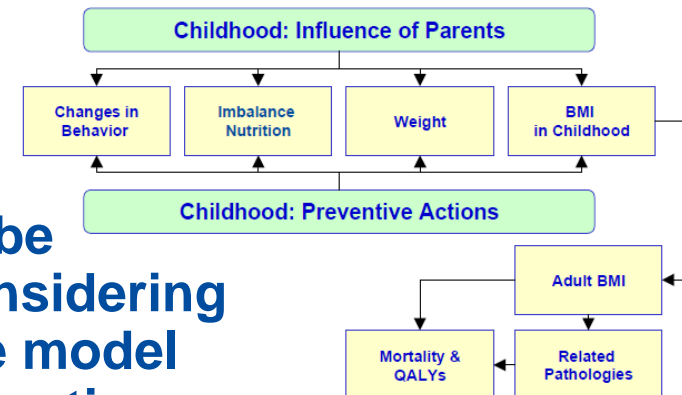

Basic Model of Obesity in Childhood

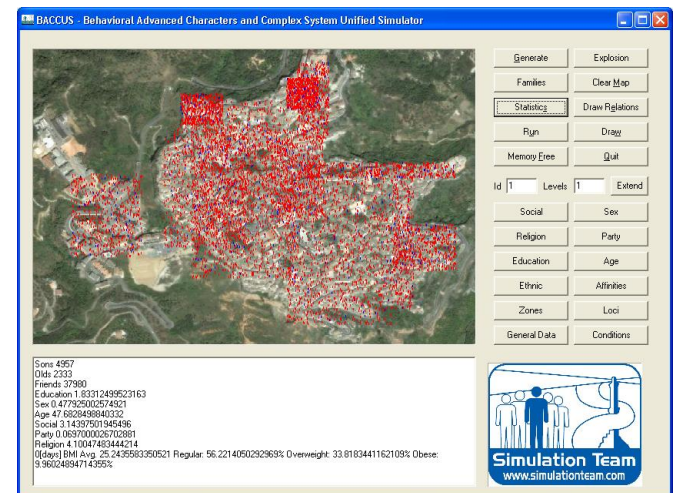



HOSSIAN

Hospital Simulation Analyzer

HOSSIAN is a tool developed to support resource planning in Hospital by integrating simulation and AI (Artificial Intelligence). The system has been successfully applied to the personnel and equipment scheduling in a Surgery Division composed by 6 operative rooms.

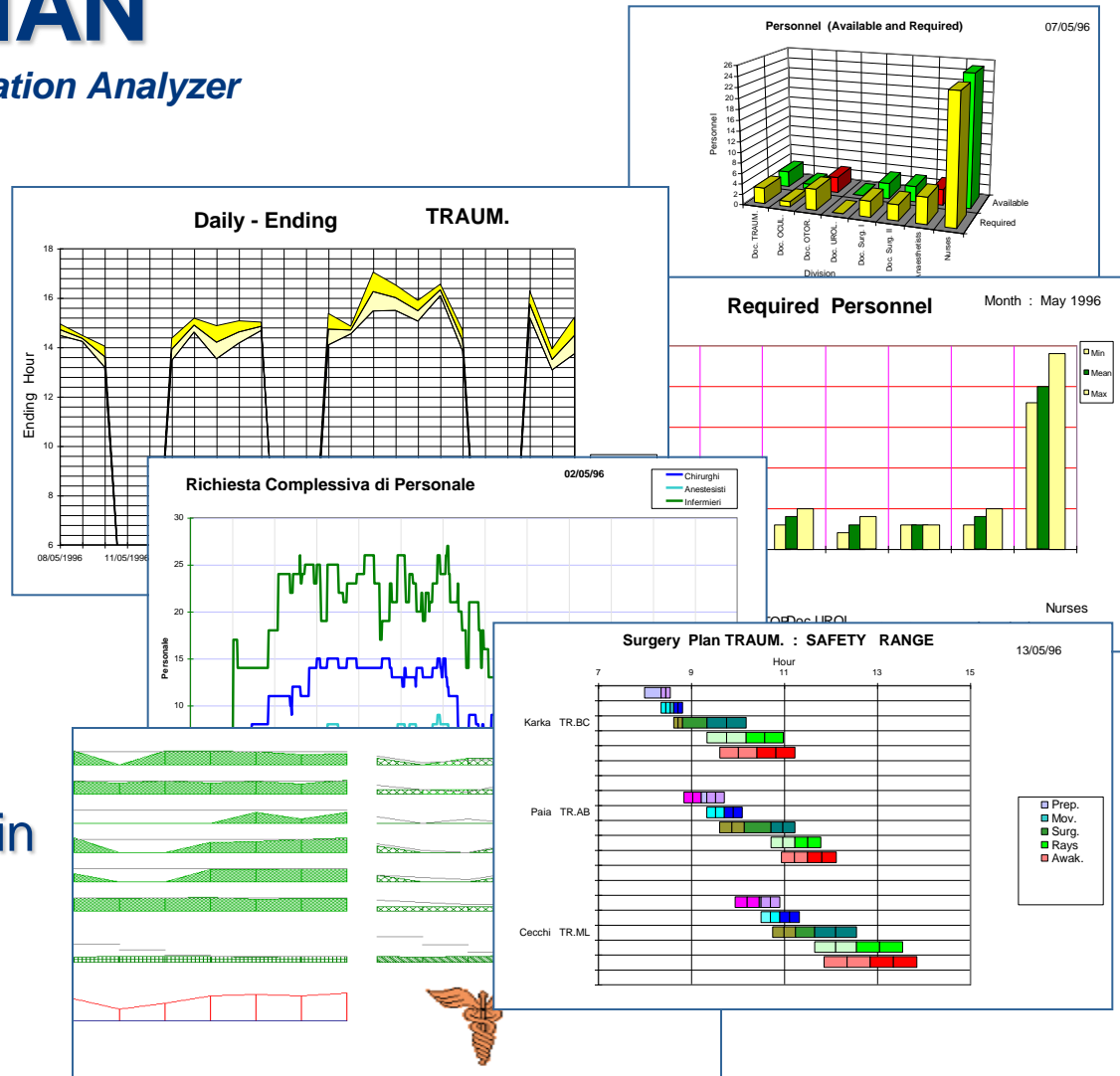



TEZNAME

Tactics Evaluation & optimiZatioN for Analysis in Medical Environment

TEZNAME is a tool for analyzing Hospital Departments Management considering the detail of each resource, individual and/or procedure.

The system has been successfully applied to Laboratory Re-engineering to compare different investments and policy/organization alternatives.

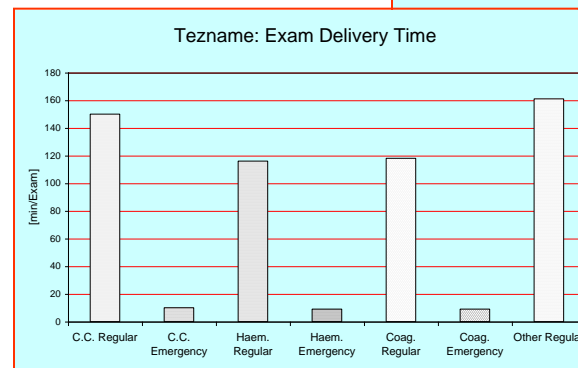

Crossing Time During the Day

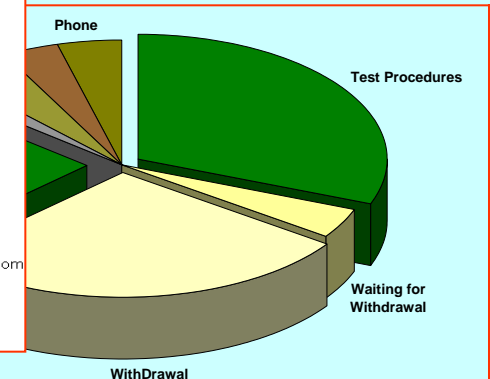
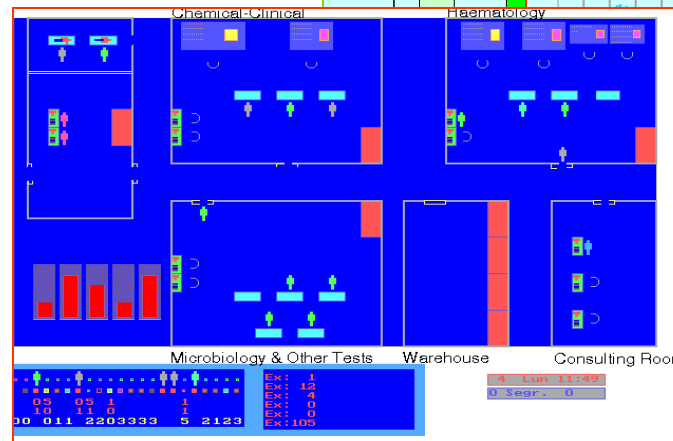
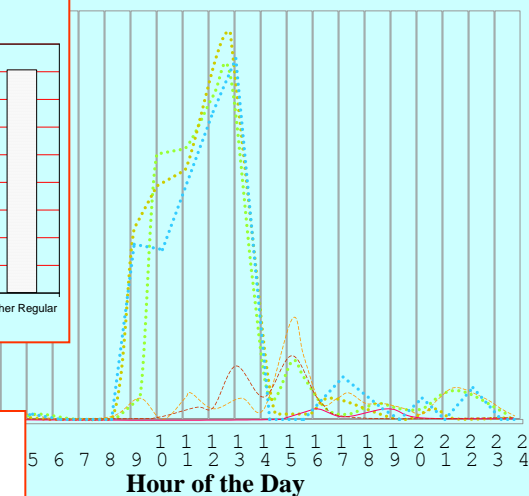



LOGIS

Long-distance tutorial network in Logistics Information Systems

LOGIS is a *Leonardo* project sponsored by European Community in order to develop Long Distance Tutorial Network in "Logistics Information System", Based on WEB Technologies. Besides the training, an interesting exploitation of the results of the research is related to the transfer of these techniques to Small - Medium size Enterprises.

 Sponsored by
European
Community

Simulation Team

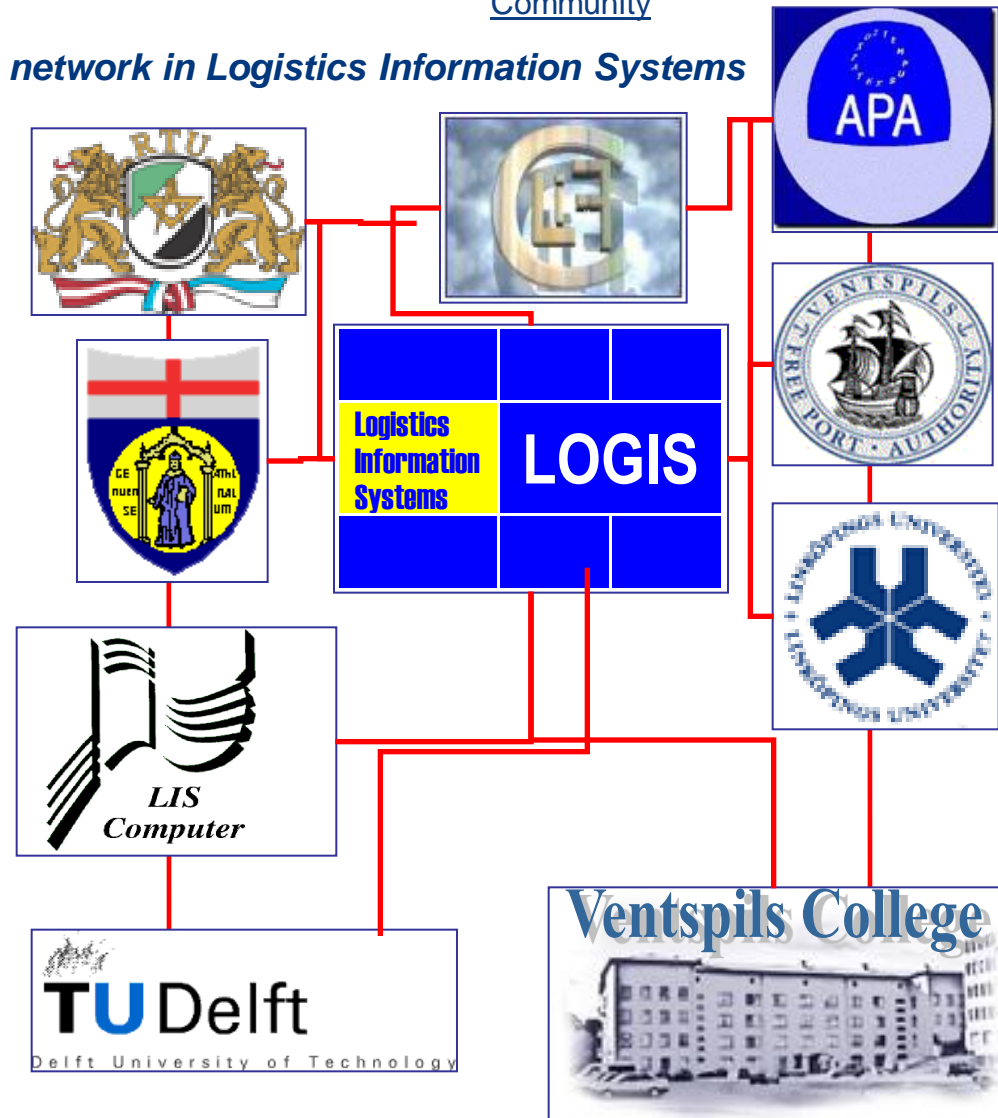



IEPAL

Intensive Educational Program in Advanced Logistics



IEPAL is a Co-funded project sponsored by European Community and US Department of Education, to live an academic & industrial training, to compare European and US way of living and working. A goal of this project will be the integration & exchange of different culture, the application of Web instrument and mobility to learn to cooperate. It is a Great Opportunity for engineering students and their curriculum to experiment in the new millennium Transatlantic Experiences in Enterprises and Universities working on Projects in **World-Wide Distributed Teams** focusing on the **Advances in Modeling & Simulation for Logistics and Supply Chain Management**

Simulation Team



Sponsored by:



FIPSE, US Department of
Education

European Community, DGEAC



University of Central
Florida



Boston College



LSIS - Marseille
University



Magdeburg University



Consorzio di Formazione
Logistica Intermodale



National Center for Simulation



LSCM

Logistics and Supply Chain Management International Master

LSCM Project is devoted to develop a Master Program for New Managers operating in Logistics and Supply Chain Management using innovative solutions such as M&S. LSCM involves an International Network with several Universities cooperating for creating this new Program.

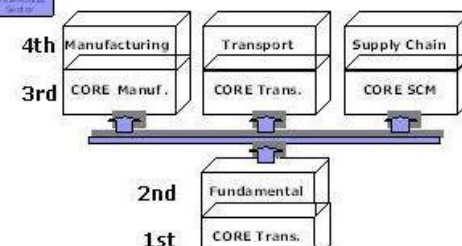
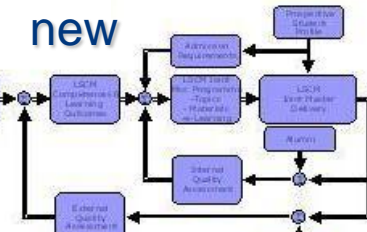

LSCM

134522-LLP-1-2007-1-ES-ERASMUS-ECDSP





MIPET Master Program

Master in Industrial Plant Engineering & Technologies
www.itim.unige.it/mipet



The Master in Industrial Plants is a Master degree program organized in Genoa University focusing on preparing new generations of top quality technical experts for process engineering and power equipment supplier as well as construction contractor. Its main aim it is to satisfy the expectation from Leading Industries in term of high technical skills and excellence capabilities in Industrial Plants and Engineering. The Master Program is directed by Faculty of Engineering in strong cooperation with leader industries and major companies operating in these industrial sectors, this aspect guarantees the relevance and effectiveness of the initiative. In fact this project it is part of a large initiative devoted to develop excellence in Industrial Plant Engineering through the synergy between the expertise of Genoa University Engineering Faculty and Top Level Companies with long traditions that are leading this Area Nationally and Internationally in term of turnovers, size, processes and products complexity as well as know how and technical skills.

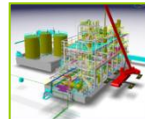

Master in Industrial Plant Engineering and Technologies

SPONSORS AND SUPPORTERS



SPONSOR COMPANIES EDITION 2010



Prof. Agostino Bruzzone www.master.itimpi.unige.it





PREMITELE Program

*Preparation for Management within
Innovative Transportation services and Evolving Logistics*



PREMITELE Program (Preparation Business Management, Transportation and Logistics) was established to provide Methodologies and Tools for Transportation Services and Logistics with special attention on the following issues:

- *Assessment and Forecasting of logistics demand while facing emerging behaviors and new trends*
- *Definition of Evaluation criteria and solution for Supply Chain Management (SCM)*
- *Planning and Management of transport and logistics services*
- *Technology Transfer and Skill Acquisition on logistics considering operations, economy, legal aspects, engineering*
- *Identification of customer needs*
- *Use of Models and Tools for operative, economic & financial analysis and evaluation of investments and management solution for transport infrastructures and logistics*
- *Marketing planning for new transportation services and logistics*
- *Development of systems of management and control for Logistics and SCM*
- *Support and Guide the public administrators and operators in decision making and in the definition and implementation of realistic and effective policies in Transportation*

The aim of the course and then PREMITELE the preparation of a new generation of experts that who could be valuable in business within the area of Logistics and Transportation Services, becoming the new leaders in this area to support developments and strategic decisions and their implementation. People involved in the program should have skills in the fundamentals of engineering, economics, and regulatory and procedural issues related to transport and logistics characteristic within their university education; the attendees are students of Engineering, Economics or Law Faculties with Genoa, Rome, Bologna, Trieste, Salerno Universities. The PREMITELE is founded by the Italian National Department of Transportation.

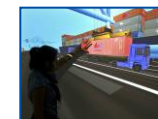



DIMS PhD Program

*phD program in Innovative Mathematical engineering,
modeling & Simulation*



DIMS is a PhD program in Mathematical Engineering and Simulation sponsored largely by Simulation Team and Specific R&D Projects such as PIOVRA and CAPRICORN.

DIMS PhD program was activated by DIPTM (Production Engineering & Mathematical Modelling Dept.) and DIBE (BioEngineering Dept.) during fall 2005; today DIMS involves about 20 Courses in M&S for PhD Students and over 20 PhD Students are enrolled in this program.

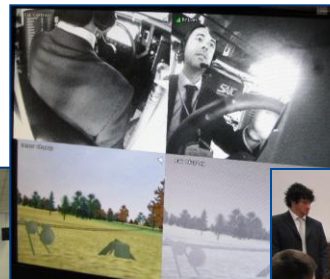



Conclusions

The Simulation Team is acting at international level as a reference point between users and providers in simulation area.

The integration of experts, technicians is providing very good results on real case studies and complex projects.

An active area of development is related to distributed simulation and web-based modeling for extending the impact and exploitation of these proposed systems.

Every year Simulation Team - MITIM DIME and Liophant organize major Conferences and International Workshops focusing on application of Modelling & Simulation.

For instance the I3M2012 was in Wien, SummerSim2011 in Genoa, WAMS2012 in Rome; in 2013 I3M it was in Athens, WAMS in Buenos Aires and Summersim in Ottawa.

There is a constant interest in fostering joint cooperation and exchanges with international Excellence Centers working on simulation.

In 2014 Prof. Bruzzone serves as General Chair of WAMS in Istanbul as well as of I3M in Rome: this last conference

represent one of the major scientific event worldwide

in simulation: i.e. the I3M2011 organized in Rome,

joint to CAX Forum, probably was the largest scientific event

in M&S worldwide, involving over 500 speakers from 52 countries and over 30 live

demonstrations (including Distributed simulation connecting NASA, MIT and Genoa University)

Simulation Team



Monterey



Bordeaux



Tampa





Potential Cooperations



Simulation Team

& NATO CAX
Forum in Rome

Simulation Team provides R&D/Scientific Opportunities such as:

- Conferences and Track Organization in event where the Simulation is Strongly Involved (i.e. SummerSim, I3M, WAMS, AMS, ect)
- Exchanges for Senior and Young Scientists
- Opportunity for Scientific Cooperations devoted to promote new developments in M&S
- Developing new Standards and Procedures in M&S
- Promoting M&S in Service of the Society
- Development of Networks of Excellence in M&S



Wien

Austria

IMAACA



Simulation Team is looking for Opportunities including:

- Activation of Innovative Simulation Projects
- Combining Simulation Team Solutions with Partner's Models as Options to be proposed to Sponsors during the Proposal Phase
- Include in Simulation Team Solutions Add-In from Partners as Option for Sponsors during the Proposal Phase
- Supporting Partners in future Proposal acting directly or as subcontractor and viceversa
- Receiving Support by Partner in future Proposal acting directly or as subcontractor



Bond graph

Summersim



References

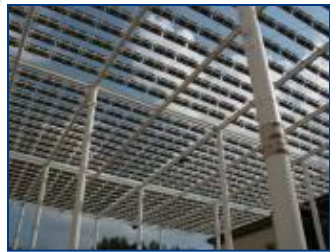
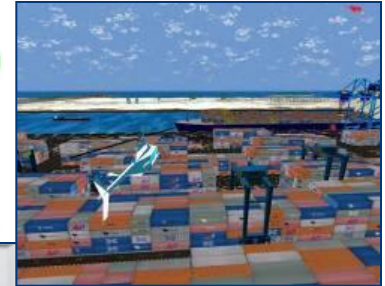

DIME



MITIM
DIME Genoa University
via Opera Pia 15
16145 Genova, Italy
www.itim.unige.it
Agostino G. BRUZZONE
agostino@itim.unige.it

